



Camera Module Product Line-up FEB.2021(Rev.01)

双峰エンタープライズ株式会社
Soho Enterprise Ltd.

OPNOUS ToF Solution with high-speed ISP ASIC on Raspi4 Ubuntu20.04



Dolphin ToF Platform is working on RaspberryPi4 (OS: Ubuntu20.04)
On board ISP realizes “easy to launch the ToF solution” on the most popular SBC.

MIPI camera version is also available.

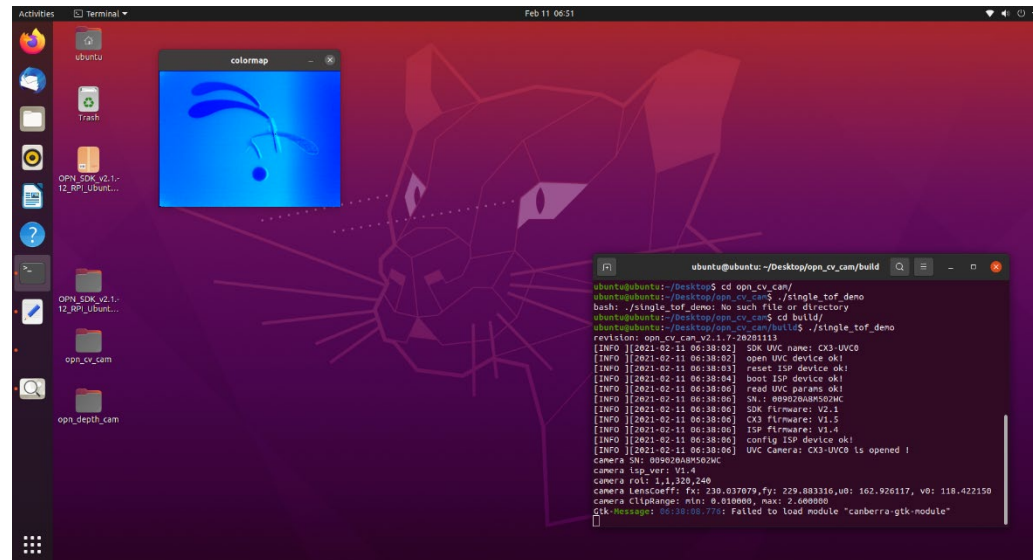
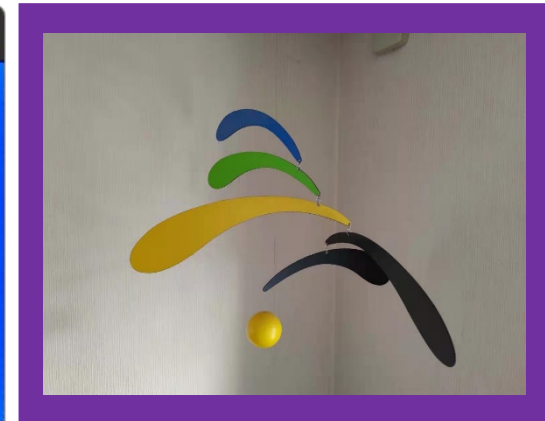
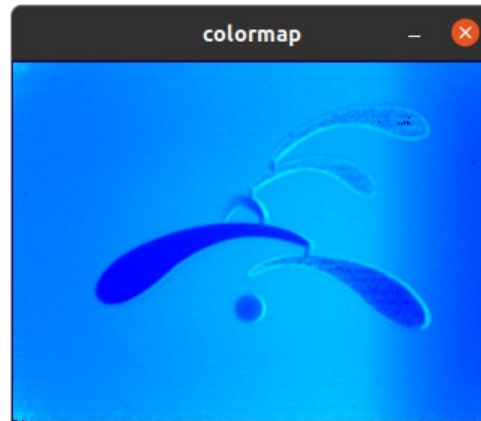
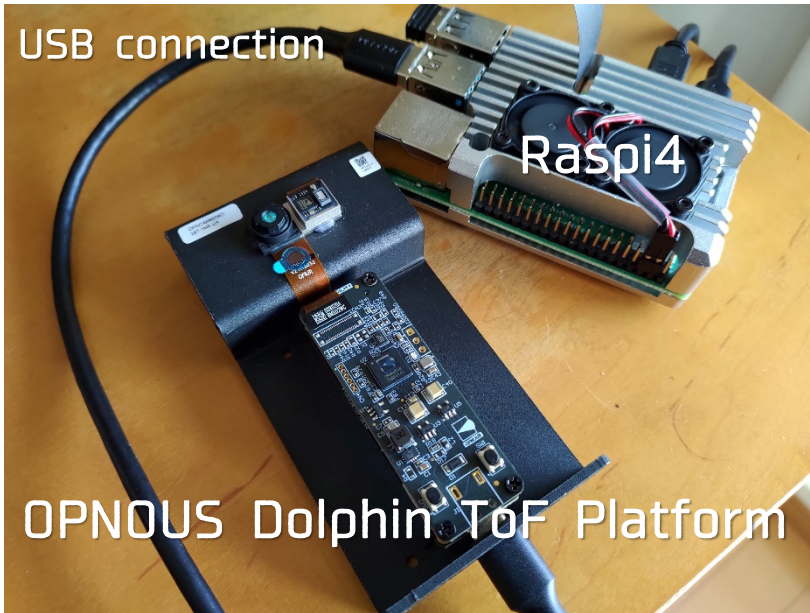

2021.2 New Release ①

SE219FF88 & SE219AF88 FoV(D)=88degree wide angle module

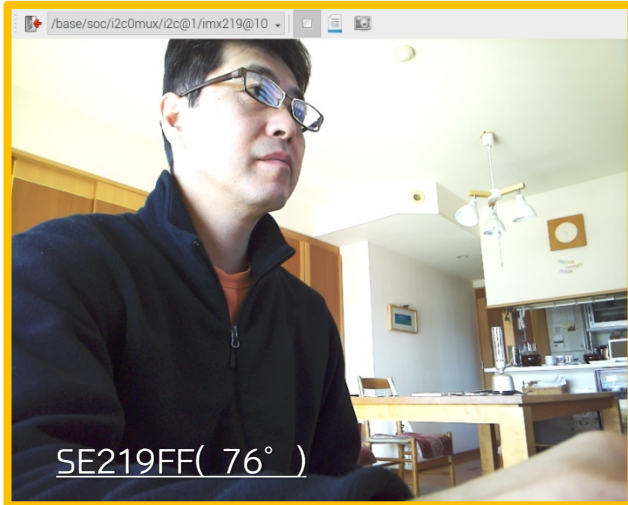
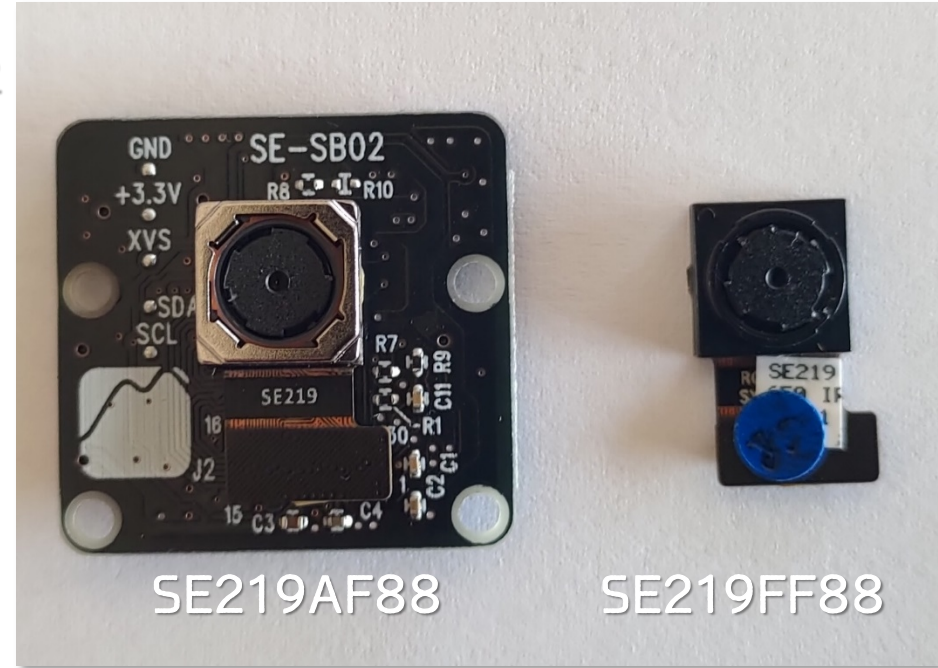
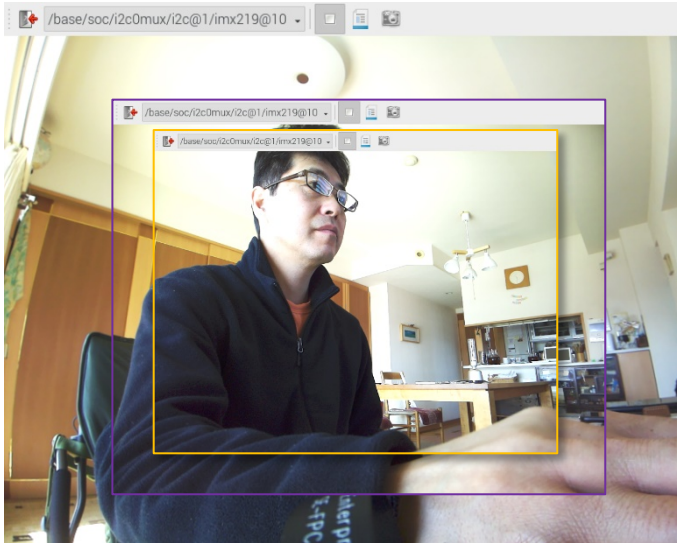

2021.2 New Release ②

SE219PKG-00/01 and SE-SB02R M12 lens holder attachable camera board

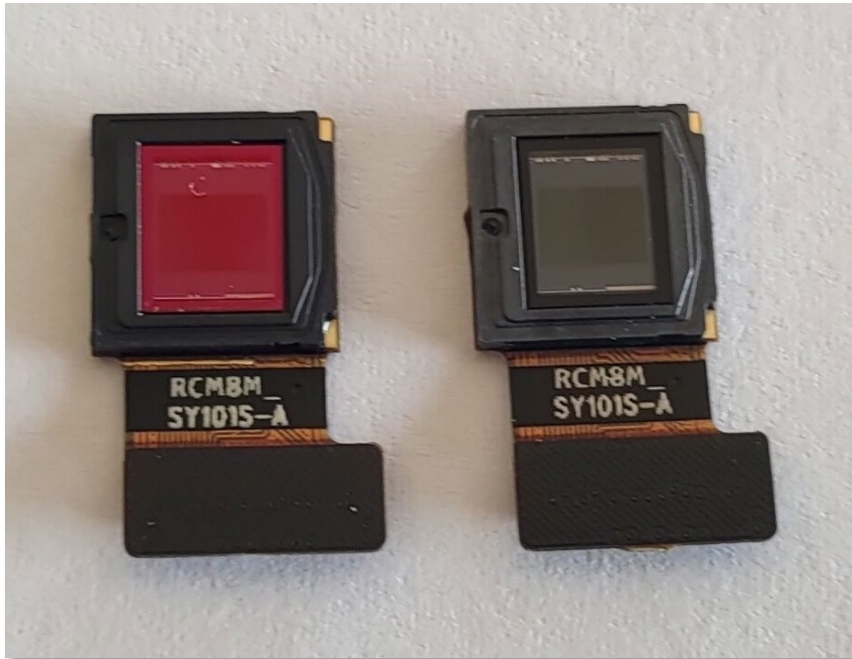

新製品予告：SE219PKG-00/01およびSE-SB02R

CMOSイメージセンサーの前面にIR CUT FILTERないし保護ガラス (NoIR)を取り付けたセンサーパッケージモジュールを企画しました。

2021年2月末からNoIRタイプのサンプル販売を予定しています。

同時に標準的なM12ホルダーを取り付け可能なセンサー基板：SE-SB02Rも発売開始します。

これにより、様々な画角のレンズの取り付けを可能にします。

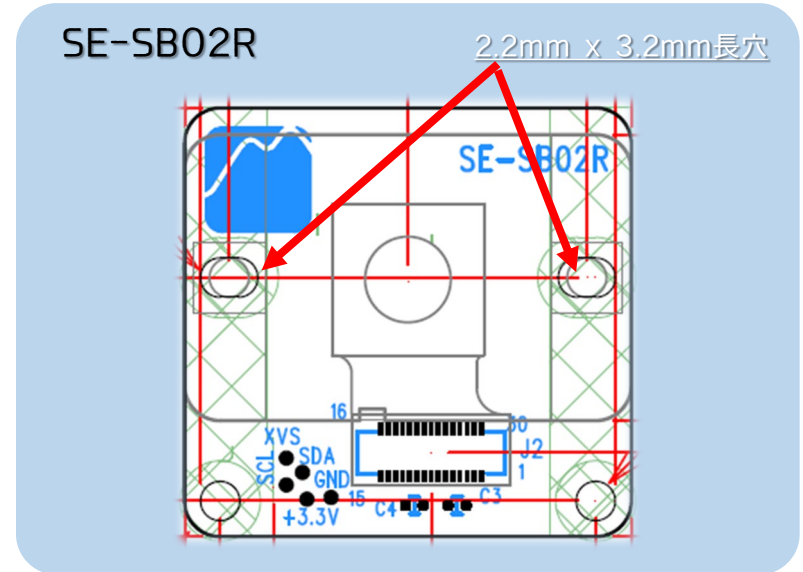
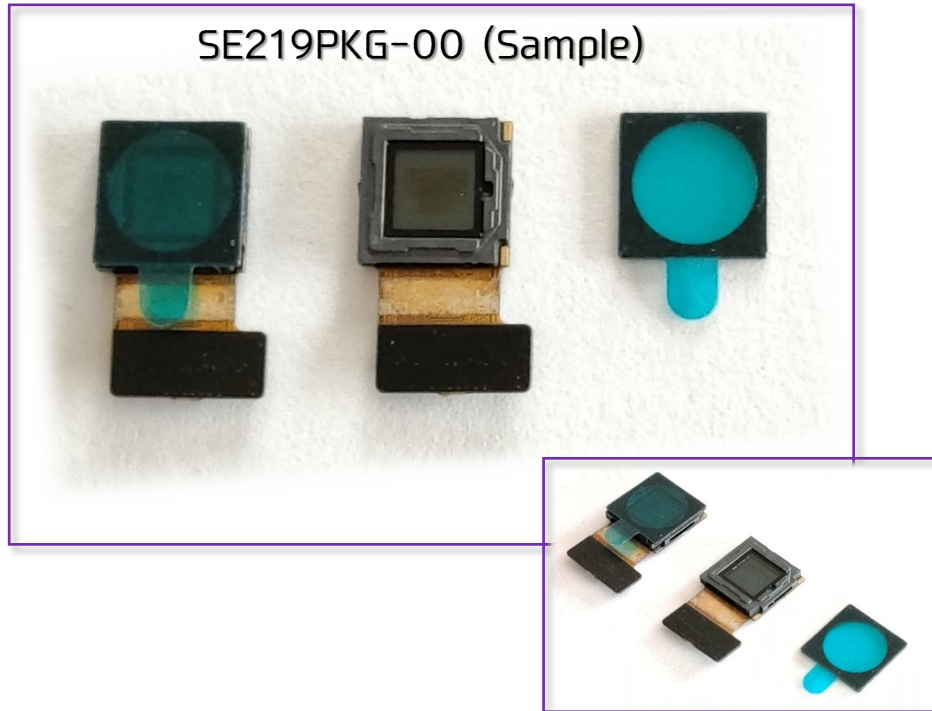

インタニヤ社の「VR 220 MOD KIT」を取り付け可能な一般的なM12ホルダーの取付穴間隔=20mmにも対応

<https://products.entaniya.co.jp/ja/products/camera-module-mod-kit/raspberry-pi/>

交換レンズ情報

<https://products.entaniya.co.jp/ja/products/camera-module-mod-kit/raspberry-pi/rp-lens/>

SBC向け小型レンズモジュール：SE219シリーズ 画角比較

新たに対角150°の広角モジュール「SE219FF150-00」がラインアップに加わりました。

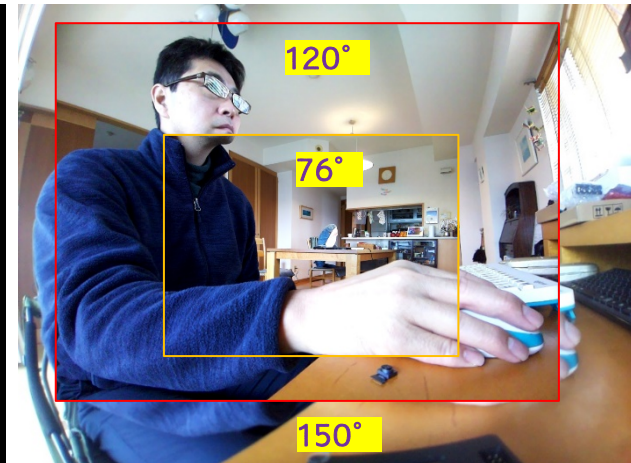
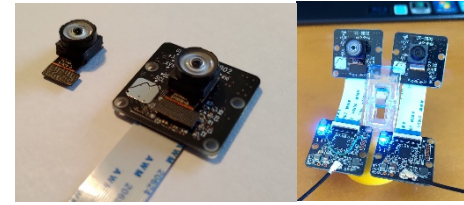

SBC向け小型レンズモジュール：SE219シリーズ ステレオ3Dカメラ応用例

76°

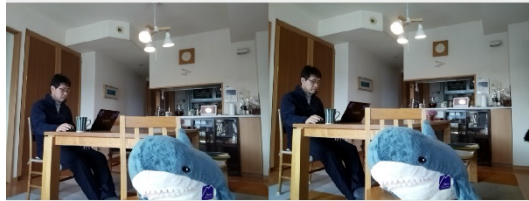

Base Line 65mm



Base Line 85mm

fx:1377 vx:160 w:834 h:618 R:100

150°



Base Line 65mm

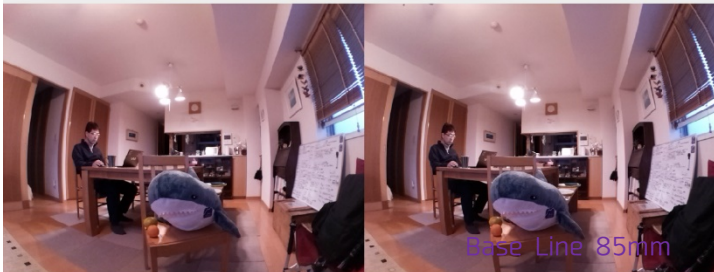

Base Line 85mm

fx:967 vx:160 w:1182 h:618 R:151

160°



Base Line 65mm



Base Line 85mm

fx:1080 vx:160 w:1314 h:618 R:157

120°

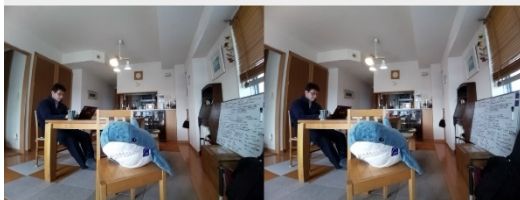

Base Line 65mm

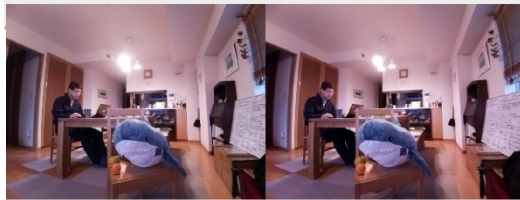

Base Line 85mm

fx:1298 vx:160 w:1044 h:618 R:100

187°



Base Line 65mm



Base Line 85mm

fx:1400 vx:160 w:1400 h:618 R:100

SE-CXB01-Tx/Rx FPD LINK III MIPI EXTENTION BOARD

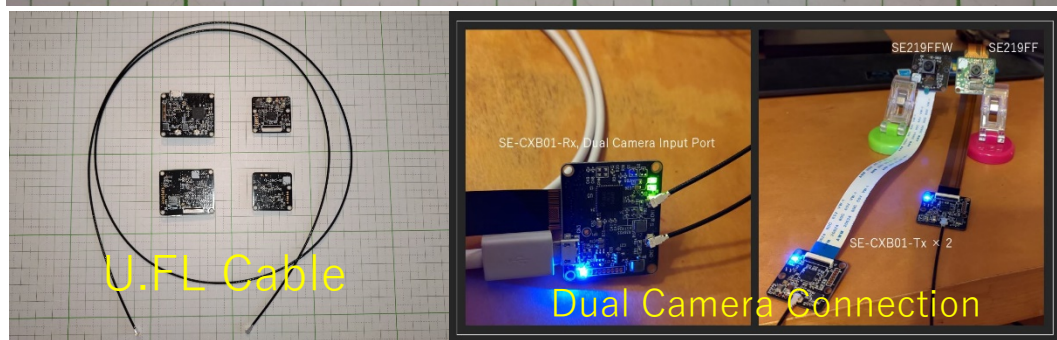
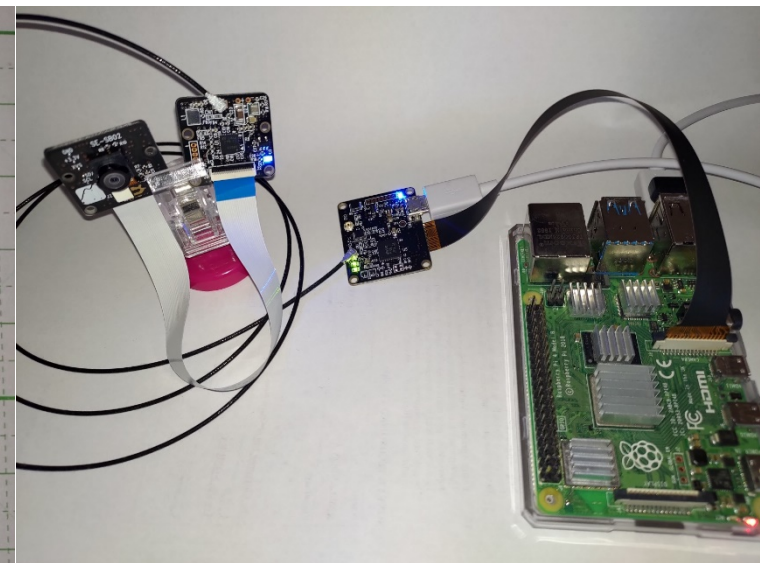
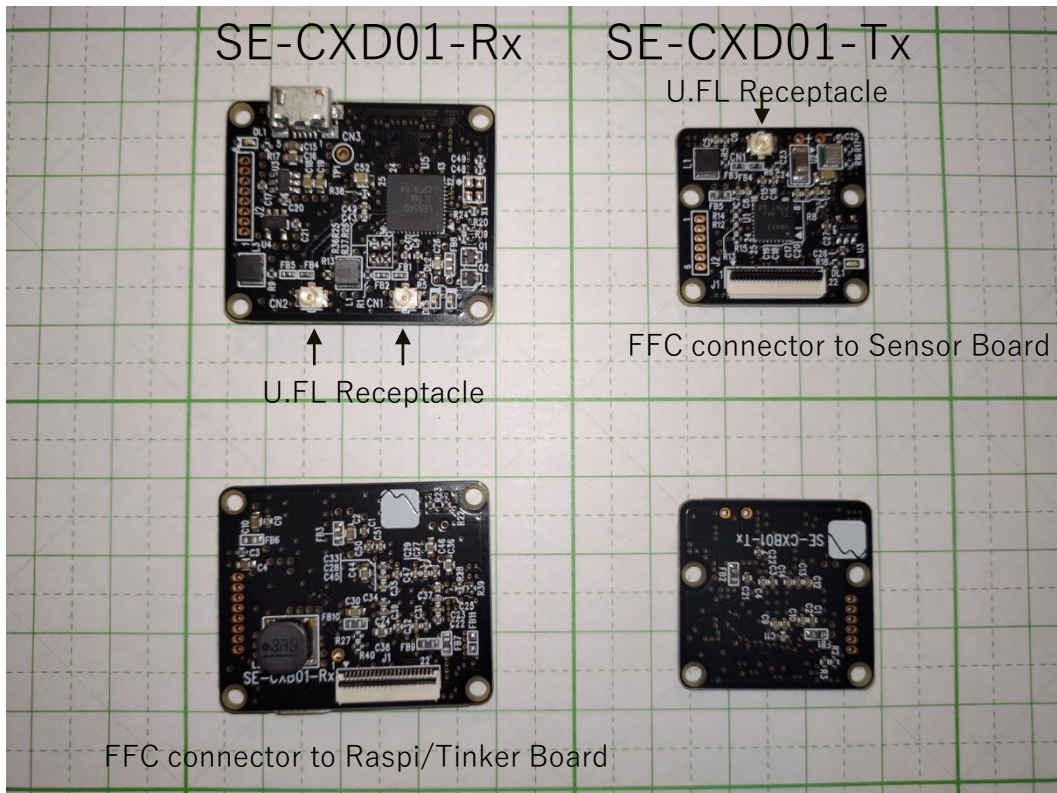

SE219FFW-00/01 and SE132GSW-01 FoV=120° 品のサンプル出荷開始

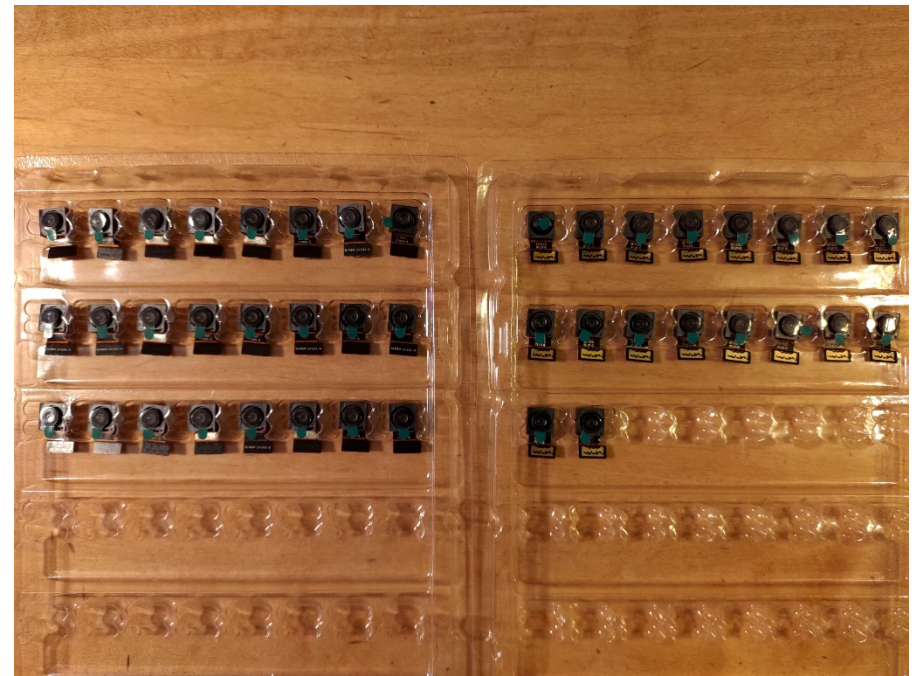
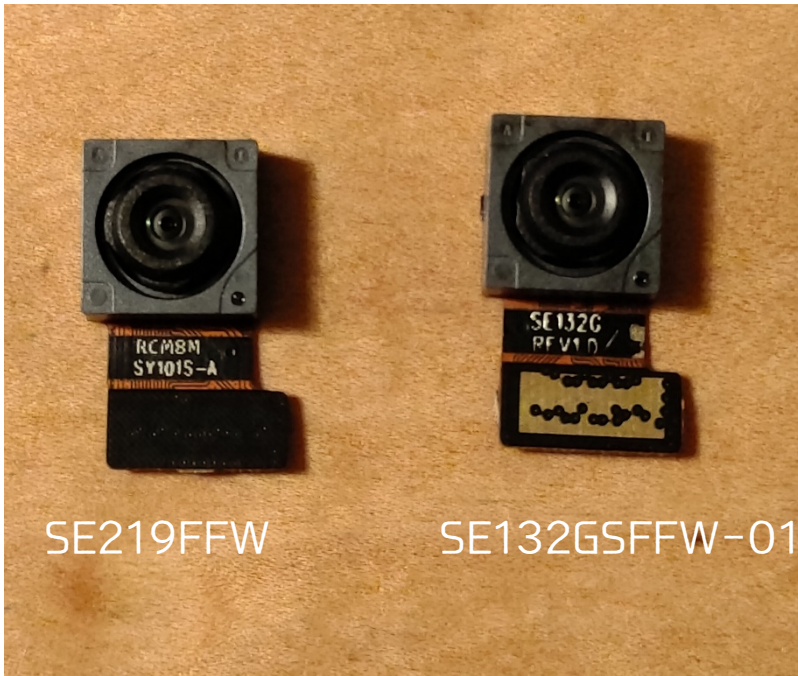

FoV(Field of View) comparison SE219FF & FE219FFW



重ねて
比較



Vision System向けイメージセンサーモジュール SE219FE-00-CB (w/ IRCF), SE219FE-01-CB (w/o IRCF)

あのIMX219が(x, y)投影サイズそのままにFoV=187°の魚眼カメラになりました。

しかも厚みは6mm以下。狭い場所に仕込むことができます。
従来製品(対角76°)に対し圧倒的な情報量の画像取得が可能です。

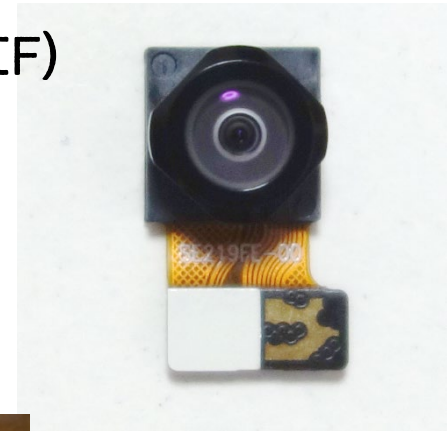

バンダイ様の人気商品
ガシャポンのザクヘッドに
ぴったり収まります。

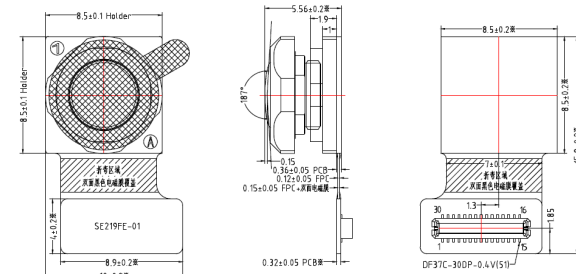



Fish Eye Camera Board w/ 8Mpix CIS for Single Board Computers

SE219FE-00/01-CB



- **Ultra Wide View Angle: FoV = 187° ± 3°**
Suitable for wide angle image recognition usage in AIoT area.
- **Adopted the most mature image sensor for SBC.**
Sony IMX219PQH5-C
- **Camera Driver with AE/AWB functions for "tinker board" is available.**
Processed in Embedded HW ISP. Full Size 20fps/FHD 30fps
- **w/ IRCF(-00), w/o IRCF(-01) modules are available**
- **Extensivity:**
FFC connector for MIPI CSI-2 4 lane connection for faster fps.
- **Ready for use**
No need remodeling the module to get wide FoV

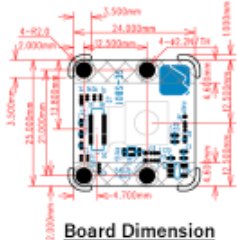

Assumed application cases

- Look down monitoring with few blind spots
- VR Stereo Vision
- Wide vision for Robots, AI speaker, any others
- Monitoring wildlife ecology, ham to agriculture
- Home-use video monitoring & recording
- 360° monitoring on drones, robot cars, etc.
- Sports camera for tennis, volleyball, badminton, etc.

Fish Eye Lens Module: SE219FE-00/01

NO.	ITEM	UNIT	MIN	MAX	REMARK	NO.	ITEM	UNIT	MIN	MAX	REMARK
1	SE219FE-00/01	mm	1.1	1.2	1.3	1	SE219FE-00/01	mm	1.1	1.2	1.3
2	SE219FE-00/01	mm	1.1	1.2	1.3	2	SE219FE-00/01	mm	1.1	1.2	1.3
3	SE219FE-00/01	mm	1.1	1.2	1.3	3	SE219FE-00/01	mm	1.1	1.2	1.3
4	SE219FE-00/01	mm	1.1	1.2	1.3	4	SE219FE-00/01	mm	1.1	1.2	1.3
5	SE219FE-00/01	mm	1.1	1.2	1.3	5	SE219FE-00/01	mm	1.1	1.2	1.3
6	SE219FE-00/01	mm	1.1	1.2	1.3	6	SE219FE-00/01	mm	1.1	1.2	1.3
7	SE219FE-00/01	mm	1.1	1.2	1.3	7	SE219FE-00/01	mm	1.1	1.2	1.3
8	SE219FE-00/01	mm	1.1	1.2	1.3	8	SE219FE-00/01	mm	1.1	1.2	1.3
9	SE219FE-00/01	mm	1.1	1.2	1.3	9	SE219FE-00/01	mm	1.1	1.2	1.3
10	SE219FE-00/01	mm	1.1	1.2	1.3	10	SE219FE-00/01	mm	1.1	1.2	1.3
11	SE219FE-00/01	mm	1.1	1.2	1.3	11	SE219FE-00/01	mm	1.1	1.2	1.3
12	SE219FE-00/01	mm	1.1	1.2	1.3	12	SE219FE-00/01	mm	1.1	1.2	1.3
13	SE219FE-00/01	mm	1.1	1.2	1.3	13	SE219FE-00/01	mm	1.1	1.2	1.3
14	SE219FE-00/01	mm	1.1	1.2	1.3	14	SE219FE-00/01	mm	1.1	1.2	1.3
15	SE219FE-00/01	mm	1.1	1.2	1.3	15	SE219FE-00/01	mm	1.1	1.2	1.3

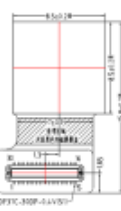
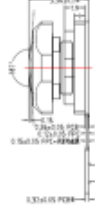
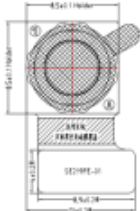

NO.	PIN NAME	NO.	PIN NAME
1	NC	16	DGND
2	NC	17	MIP1-D0N
3	DIVDD1.5V	18	MIP1-D0P
4	DIVDD1.5V	19	DGND
5	SENSOR-PH0N	20	MIP1-CLN
6	DGND	21	MIP1-D0P
7	MCLK	22	DGND
8	DGND	23	MIP1-D0N
9	ASND	24	MIP1-D0P
10	AVDDC1.5V	25	DGND
11	SPI0-KVSI	26	MIP1-CLKN
12	DGND	27	MIP1-CLKP
13	MIP1-D0P	28	DGND
14	MIP1-D0N	29	SCLL1.5V
15	DGND	30	SCAL1.5V

Same (x, y) form factor & compatible pin assignment w/ the module on Raspberry Camera V2.1

Ver. 1.1.0

Key Specifications SE219FE-00/01-CB

Category	Item	Specification	Detail
Image Sensor	Manufacturer	Sony	Back-side illuminated CMOS image sensor
	Pixel size	1.12um x 1.12um	
	Active Image Area	3280 x 2464 8Mpix	
	Optical Size	Type 1/4 Diagonal 4.60mm	
	Operation Temperature	-20~60°C Function guarantee -20~60°C Performance guarantee	
	Storage Temperature	-30~80°C	
Lens	Configuration	Type 1/4, 6P	
	FoV	187° ± 3°	
	F No.	2.10 ± 6%	
	Focus range	30cm ~ Infinity, Adjusted at 60cm when shipped.	
Module	Connector	30pin	Compatible w/ Raspi Camera v2.1 module
	Size	8.5mm*8.5mm*5.56mm	Lens Holder size. Same (x, y) size to Raspi module
	Weight	0.4g	
	Power Supply	Analog Digital IO	2.8V ± 0.2V 1.2V ± 0.12V 1.8V ± 0.18V
Board	Size	25mm*24mm	Almost same size and compatible position for screw holes with RaspberryPi camera V2.1.
	Connector	1.0mm pitch 15pin 0.5mm pitch 22pin	For Tinker board, RaspberryPi RaspberryPi0, Raspi compute module, etc.
	Output	I/O Format	Support MIPI CSI-2 2lane and 4 lane
		Maximum speed	Full size: 30fps, FHD: 60fps, 720P: 180fps (MIPI 4 lane mode)
	Power Supply		Generate Analog 2.8V by on-board LDO
			Generate Digital 1.2V by on-board DD-converter.
		Generate Analog 1.8V by on-board LDO Generate AF 2.8V by on-board optional LDO	

Why are the SE camera boards suitable for AIoT vision processing applications?

- Good image quality**
The SE camera series uses a high-quality Sony image sensors of better SNR.
- Ready to use on tinker board and other SBCs**
Camera drivers are ready. Easy to customize for PoC prototyping
- Variety of Options**
Wide variety of options for resolution, global shutter, wide FoV lens, focus driver, etc.
- Low Latency, RAW image**
Suitable for real-time autonomous control system
- Affordable for everyone**
Pricing that individuals can purchase from a single item in line with the corporate philosophy of *helping to create open innovation.*

Further Information:

<https://soho-enterprise.com/>
<https://www.visionproc.org/index.php>



Ver. 1.1.0

魚眼カメラ応用事例：detect_cat（アプリSW配布中。）



魚眼カメラ応用事例：魚眼スポーツカム

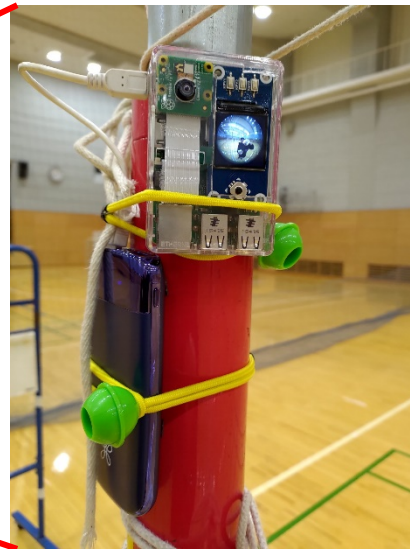
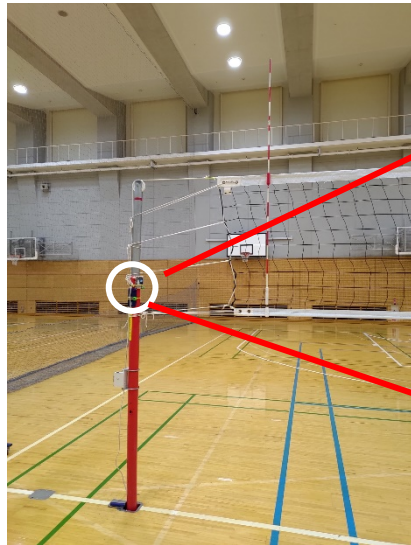

広角レンズモジュールのVision Processing適用事例

認識系アプリ



Coyote Racer

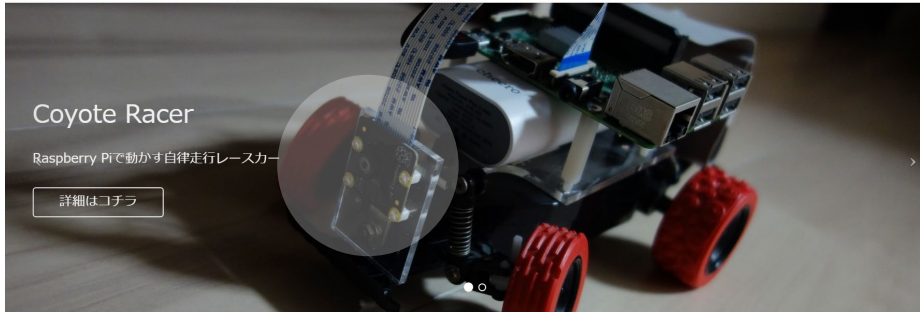

測距系アプリ

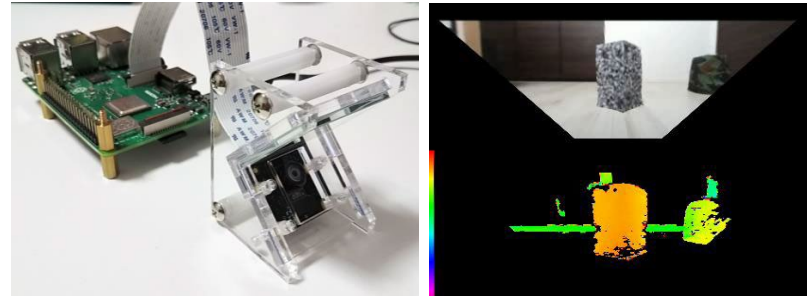

超広角応用ステレオ測距

Line laser depth module

FoV~135deg
Processing time~15ms/frame

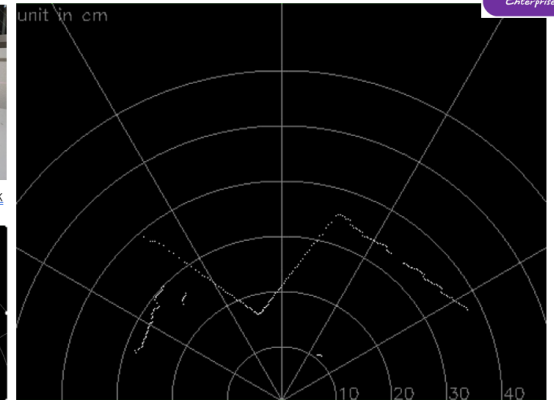
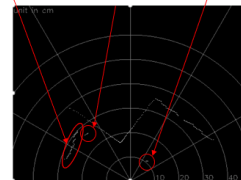
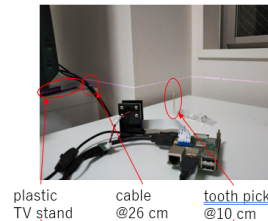

CQ出版社 Interface
2020年3月号に特集記事掲載→



ラインレーザー+単眼ステレオ測距
132° 広角レーザーとの組み合わせ

Vision System向けイメージセンサーモジュール SE219AF-00-CB (w/ IRCF), SE219AF-01-CB (w/o IRCF)

想定適用例：AR/VRゴーグル用カメラ、スマートグラス、ウェアラブルカメラ

FoV=76°、待望のフォーカスドライバ内蔵のIMX219カメラモジュール
3cm～無限遠(要調整)でフォーカス合わせが可能。
シャープなイメージのマクロ撮影において特に性能を発揮
Tinker BoardのカメラドライバーにAF機能実装検討中

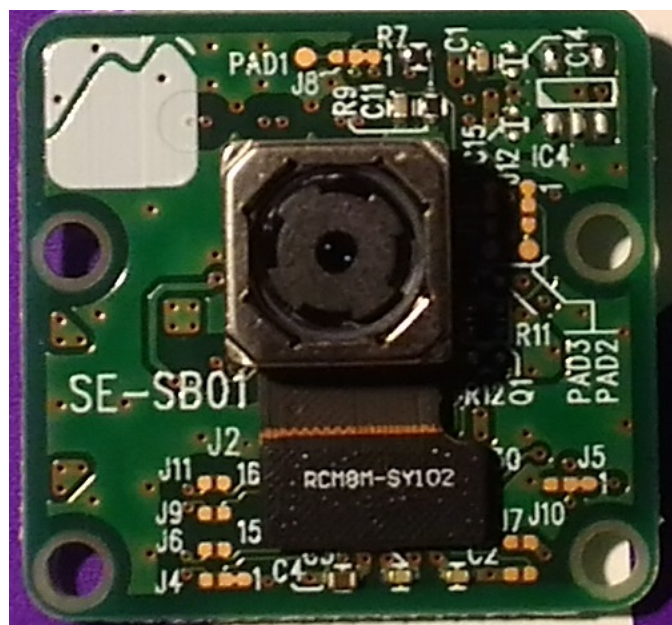

FoV=160° 魚眼カメラ SE219FE160-00-CB (w/ IRCF), SE219FE160-01-CB (w/o IRCF)

想定適用例：広角3D動画、ドアホン、見守り監視、自律移動ロボットのセンシングなど。



Soho Enterprise Ltd.

SE Camera Board Series Product Brochure

Fish-Eye lens nodule w/ 8Mpix CIS for Single Board Computers

SE219FE160-00/01

- Ultra Wide View Angle: FoV = 160° ± TBD°
Suitable for wide angle image recognition usage in AIoT area.
- Adopted the most mature image sensor for SBC.
Sony IMX219PQH5-C
- w/ IRCF (-00), w/o IRCF (-01) modules are available
- Extensivity:
FFC connector for MIPI CSI-2 4 lane connection for faster fps.

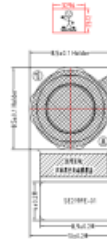

To Be Replaced

Pin Assignment

No.	Pin Name	No.	Pin Name
1	NC	26	DGND
2	NC	27	MPI-D0N
3	DVDD1.2V	28	MPI-DSP
4	DVDD1.2V	29	DGND
5	Sensor-PWDN	30	MPI-D0N
6	DGND	31	MPI-DSP
7	MCLK	32	DGND
8	DGND	33	MPI-D0N
9	AGND	34	MPI-DSP
10	MCLK	35	DGND
11	SPDVI0E	36	MPI-CLKP
12	DGND	37	MPI-CLKP
13	MPI-DSP	38	DGND
14	MPI-D0N	39	SCL1.8V
15	DGND	40	SCL1.8V

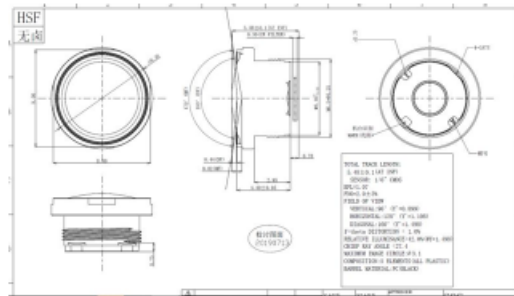

IMX219
D=4.6mm

Imaging area & Image circle

Assumed application cases

- Look down monitoring with few blind spots
- Monitoring wildlife ecology, harm to agriculture
- OVR Stereo Vision
- Home-use video monitoring & recording
- Wide vision for Robots, AI speaker, any others

SE Camera Board Series Product Brochure

Key Specifications		SE219FE-00/01-CB	
Image Sensor	Manufacturer	Sony	Back-side illuminated CMOS image sensor
	Pixel size	1.12um x 1.12um	
	Active Image Area	3280 x 2464	8Mpix
	Optical Size	Type 1/4 Diagonal	4.60mm
Lens	Operation Temperature	-20~80°C	Function guarantee
	Storage Temperature	-20~80°C	Performance guarantee
	Configuration	Type 1/6, 5P	
	FoV	160°	±(TBD)°
Module	F No.	2.0 ± 5%	
	Focus range	30cm ~ Infinity	Adjusted at 60cm when shipped (TBD)
	Connector	30pin	Compatible w/ Raspi Camera v2.1 module
	Size	8.5mm*8.5mm*TBDmm	Lens Holder size: Same (x, y) size to Raspi module
Power Supply	Weight	0.4g(Tentative)	
	Analog	2.8V ± 0.2V	
Board (option)	Digital	1.2V ± 0.12V	
	IO	1.8V ± 0.18V	
Board (option)	Size	25mm*24mm	Almost same size and compatible position for screw holes with RaspberryPi camera v2.1.
	Connector	1.0mm pitch 15pin	For Tinker board, RaspberryPi
	I/O Format	0.5mm pitch 22pin	RaspberryPi0, Raspi compute module, etc.
	Output	Maximum speed	Support MIPI CSI-2 2lane and 4 lane
Power Supply	Full size	30fps, FHD: 60fps, 720P: 180fps	(MIPI 4 lane mode)
	Generate Analog	2.8V by on-board LDO	
	Generate Digital	1.2V by on-board DO-converter.	
	Generate Analog	1.8V by on-board LDO	
	Generate AF	2.8V by on-board optional LDO	

Why are the SE camera boards suitable for AIoT vision processing applications?

- Good image quality**
The SE camera series uses a high-quality Sony image sensors of better SNR.
- Ready to use on tinker board and other SBCs**
Camera drivers are ready. Easy to customize for PoC prototyping
- Variety of Options**
Wide variety of options for resolution, global shutter, wide FoV lens, focus driver, etc.
- Low Latency, RAW image**
Suitable for real-time autonomous control system
- Affordable for everyone**
Pricing that individuals can purchase from a single item in line with the corporate philosophy of *helping to create open innovation.*

Further Information:
<https://soho-enterprise.com/>
<https://www.visionproc.org/index.php>



2018年製品、量産出荷中

Vision System向けイメージセンサーモジュール第一弾
SE397GS-00/01-CB, SE397GSW-00-CB
 High speed global shutter camera

画素ピッチ：3.45um (IMX219は1.12um)で高感度
 すなわち高速シャッターがきれる。
 動被写体を、ボケ、歪みを少なく撮影できる！
 FoV=90° および180° 品、
 90° 品はIRCF 有/無 選択可能

SE397GS-01-CB



FoV 90° NoIR

SE397GSW-00-CB



Diagonal 2.799 mm (Type 1/6.4) 0.32 Mega-Pixel (VGA) CMOS Image Sensor with Square Pixel for B/W Cameras

IMX397CLN-C

Pregius

Description

IMX397CLN-C is a diagonal 2.799 mm (Type1/6.4) 0.32 Mega-pixel CMOS active pixel type image sensor with a square pixel array. By introducing Global Shutter technology with low PLS (Parasitic Light Sensitivity), high sensitivity and low noise, motion blur is suppressed. It equips an electronic shutter with variable integration time. It operates with three power supply voltages: analog 2.8 V, digital 1.2 V and 1.8 V for input / output interface and achieves low power consumption.

(Application: FA Cameras, Sensing)

Features

- ◆ CSI-2 serial data output (DPHY ver1.1 compliant)
- ◆ 2-wire serial communication circuit
- ◆ 10-bit A/D converter
- ◆ CDS / PGA (digital 24dB, analog 18dB)
- ◆ Automatic optical black clamp circuit
- ◆ Variable-speed electronic shutter (1H units)
- ◆ Independent flipping and mirroring
- ◆ Pixel binning readout and H / V sub-sampling function
- ◆ Dual sensor synchronization operation
- ◆ Trigger (Internal & External)

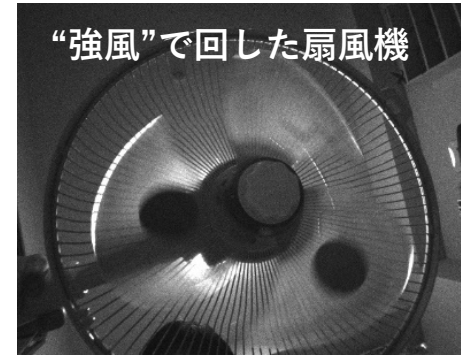

Rolling Shutter



Motion Blur



Global Shutter



<https://www.teledynedalsa.com/en/learn/knowledg-e-center/global-shutter-imaging/>

IMX397 Camera Lens Module

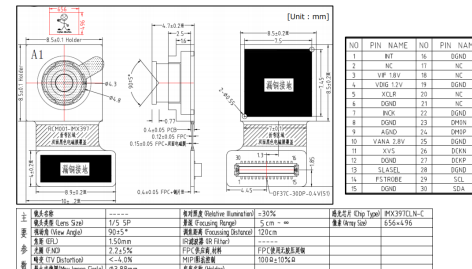



Global Shutter Camera Board w/ VGA CIS for Single Board Computers

SE397GS-00/01-CB



- **Adopted Sony Global Shutter Image Sensor**
Sony IMX397CLN-C high sensitivity GS CIS
- **Wide View Angle: FoV(D) -90° ±5°**
Suitable for wide angle image recognition usage in AIoT area
- **High Speed Operation**
Up to 240fps
- **Camera Driver for "tinker board" is available.**
Tinker board & RaspberryPi in RAW capture mode
- **Extensivity:**
Synchronization by XVS (GPIO)
- **w/ IRCF(-00), w/o IRCF(-01) modules are available**
- **Ultra-Wide-Angle Option: FoV(D)-180° (Tentative)**

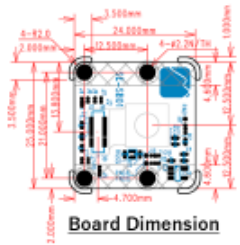

Board Dimension



Ultra Wide Lens Option



Fan in Motion

Assumed application cases

- Machine vision for the object in fast motion
- Vision analysis in sports training
- Biometrics
- Measurement device to adjust the mechanical timing
- Stereo depth measurement in motion
- Motion capture for gesture control in VR game
- Motion capture for computer graphic animation



Global Shutter Camera Module SE397GS (Tentative Spec.)

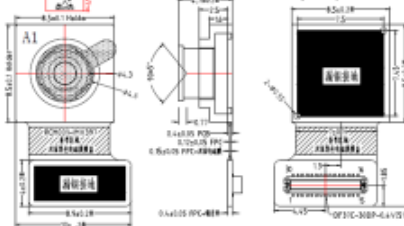

Same (x, y) form factor & compatible pin assignment w/ Raspberry Camera V2.1

NO	PIN NAME	NO	PIN NAME
1	INT	16	DGND
2	NC	17	NC
3	VIF 1.8V	18	NC
4	VDIG 1.2V	19	DGND
5	XXLR	20	NC
6	DGND	21	NC
7	INCK	22	DGND
8	DGND	23	DMEN
9	AGND	24	DMEN
10	VANA 2.8V	25	DGND
11	XVS	26	BCM
12	DGND	27	BCM
13	SLASEL	28	DGND
14	FSTROBE	29	SCL
15	DGND	30	SDA

NO	ITEM	UNIT	VALUE	NO	ITEM	UNIT	VALUE	NO	ITEM	UNIT	VALUE
1	SENSOR	1/2.5"	1/2.5"	1	POWER SUPPLY	3.3V	3.3V	1	SENSOR	1/2.5"	1/2.5"
2	SENSOR	1/2.5"	1/2.5"	2	POWER SUPPLY	1.2V	1.2V	2	SENSOR	1/2.5"	1/2.5"
3	SENSOR	1/2.5"	1/2.5"	3	POWER SUPPLY	1.8V	1.8V	3	SENSOR	1/2.5"	1/2.5"
4	SENSOR	1/2.5"	1/2.5"	4	POWER SUPPLY	2.8V	2.8V	4	SENSOR	1/2.5"	1/2.5"
5	SENSOR	1/2.5"	1/2.5"	5	POWER SUPPLY	3.3V	3.3V	5	SENSOR	1/2.5"	1/2.5"
6	SENSOR	1/2.5"	1/2.5"	6	POWER SUPPLY	3.3V	3.3V	6	SENSOR	1/2.5"	1/2.5"
7	SENSOR	1/2.5"	1/2.5"	7	POWER SUPPLY	3.3V	3.3V	7	SENSOR	1/2.5"	1/2.5"
8	SENSOR	1/2.5"	1/2.5"	8	POWER SUPPLY	3.3V	3.3V	8	SENSOR	1/2.5"	1/2.5"
9	SENSOR	1/2.5"	1/2.5"	9	POWER SUPPLY	3.3V	3.3V	9	SENSOR	1/2.5"	1/2.5"
10	SENSOR	1/2.5"	1/2.5"	10	POWER SUPPLY	3.3V	3.3V	10	SENSOR	1/2.5"	1/2.5"
11	SENSOR	1/2.5"	1/2.5"	11	POWER SUPPLY	3.3V	3.3V	11	SENSOR	1/2.5"	1/2.5"
12	SENSOR	1/2.5"	1/2.5"	12	POWER SUPPLY	3.3V	3.3V	12	SENSOR	1/2.5"	1/2.5"
13	SENSOR	1/2.5"	1/2.5"	13	POWER SUPPLY	3.3V	3.3V	13	SENSOR	1/2.5"	1/2.5"
14	SENSOR	1/2.5"	1/2.5"	14	POWER SUPPLY	3.3V	3.3V	14	SENSOR	1/2.5"	1/2.5"
15	SENSOR	1/2.5"	1/2.5"	15	POWER SUPPLY	3.3V	3.3V	15	SENSOR	1/2.5"	1/2.5"

Ver. 1.2.0

Key Specifications SE397GS-CB

Category	Item	Value	Value
Image sensor	Manufacturer	Sony	Back-side illuminated CMOS image sensor
	Pixel size	3.45um x 3.45um	
	Active Image Area	640 x 480 VGA	
	Optical Size	Type 1/6.4 Diagonal 2.80mm	
	Operation Temperature	-30~75°C Function guarantee -10~60°C Performance guarantee	
	Storage Temperature	-40~80°C	
Lens	Lens configuration	GS: Type 1/5 5P, GSW: Type 1/4 6P	
	FoV	GS: 90° ±5°, GSW: 180° ±3° (diagonal)	
	F No.	GS: 2.2±5%, GSW: 2.1±5%	
	Focus range	5cm - Infinity, Adjusted at 120cm when shipped (GS), TBD for GSW	
Module	Connector	30pin	Compatible w/ Raspi Camera v2.1 module
	Size	8.5mm*8.5mm *4.7mm	Lens Holder size Same (x, y) form factor to Raspi module
	Weight	0.4g	
	Power Supply	Analog	2.8V ±0.2V
		Digital	1.2V ±0.12V
		ID	1.8V ±0.18V
Board	Size	25mm*24mm	Almost same size and compatible position for screw holes with RaspberryPi camera V2.1.
	Connector	1.0mm pitch 15pin	For Tinker board, RaspberryPi
		0.5mm pitch 22pin	RaspberryPi0, Raspi compute module, etc.
	I/O Format		Support MIPI CSI-2 1lane
	Output	Maximum speed	Full size: 240fps
	Power Supply	3.3V ±0.3V	Generate Analog 2.8V by on-board LDO Generate Digital 1.2V by on-board DD-converter Generate Analog 1.8V by on-board LDO Generate AF 2.8V by on-board optional LDO

Why are the SE camera boards suitable for AIoT vision processing applications?

1. **Good Image quality**
The SE camera series uses a high-quality Sony image sensor of better SNR.
2. **Ready to use on tinker board and other SBCs**
Camera drivers are ready. Easy to customize for PoC prototyping
3. **Variety of Options**
Wide variety of options for resolution, global shutter, wide FoV lens, focus driver, etc.
4. **Low Latency, RAW image**
Suitable for real-time autonomous control system
5. **Affordable for everyone**
Pricing that individuals can purchase from a single item in line with the corporate philosophy of helping to create open innovation.

Further Information:

<https://soho-enterprise.com/>
<https://www.visionproc.org/index.php>



Ver. 1.2.0

New Release

Vision System向けイメージセンサーモジュール

SE132GSFF-00/01-CB02

SE132GSFE160-00/01-CB02

中国SMARTSENS TECHNOLOGY社の最新Global Shutter Image Sensorをモジュール化しました。

最高品質の台湾TSMC社で製造される裏面照射型イメージセンサーです。

画素サイズ2.7um, 1,080x1,280=1.3Mpixel

SE219シリーズと同じ光学サイズ1/4”型で豊富なレンズバリエーションが用意できます。

- ・ 120fpsの高速撮像
- ・ 赤外領域の感度が向上
- ・ RaspberryPiとの接続を確認済み
- ・ FoV=120°、150度° 187° 等計画中

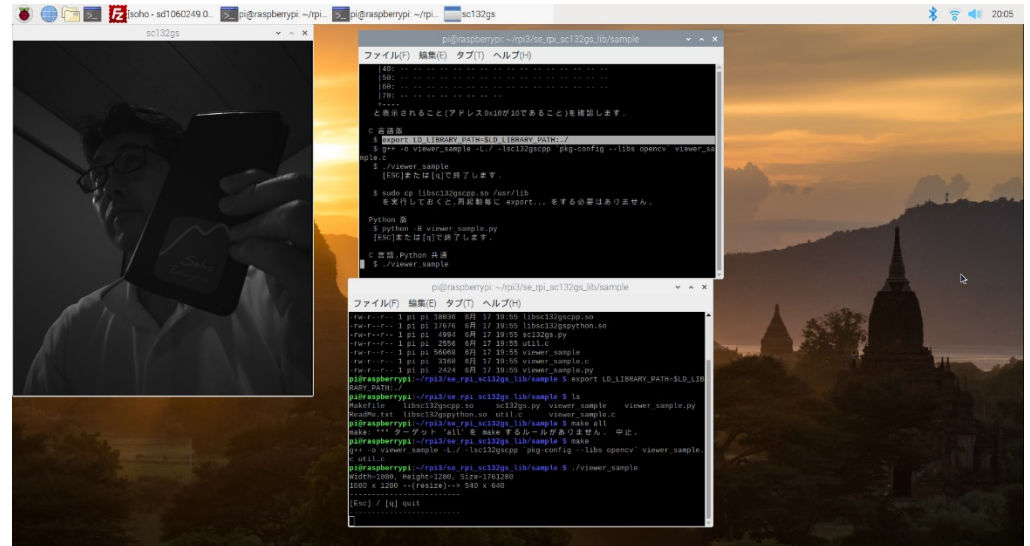

Fish-Eye lens module w/ 1.3Mpix Global Shutter CIS for SBCs

SE132GSFE160-00/01

Ultra Wide View Angle: FoV = 160° ± (TBD)*

Suitable for wide angle image recognition usage in AIoT area.

Adopted the best in class global shutter CMOS image sensor of BSI. Smartsens SC132GS

w/ IRCF(-00), w/o IRCF(-01) modules are available
Customized Band Path Filters are also available

Extensivity:
MIPI CSI-2 4 lane connection for faster fps.

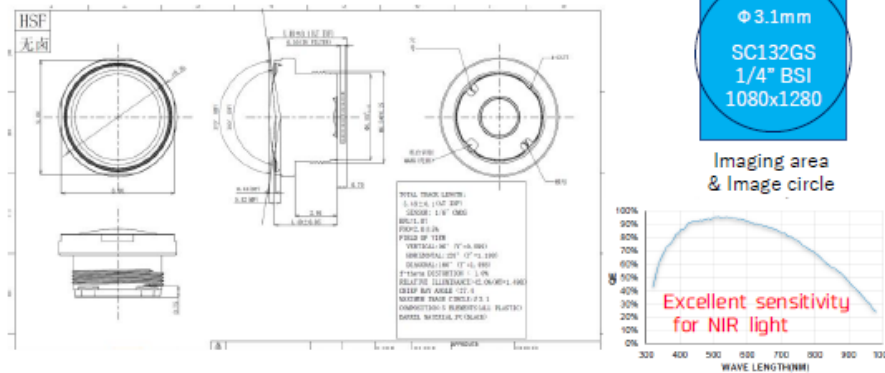
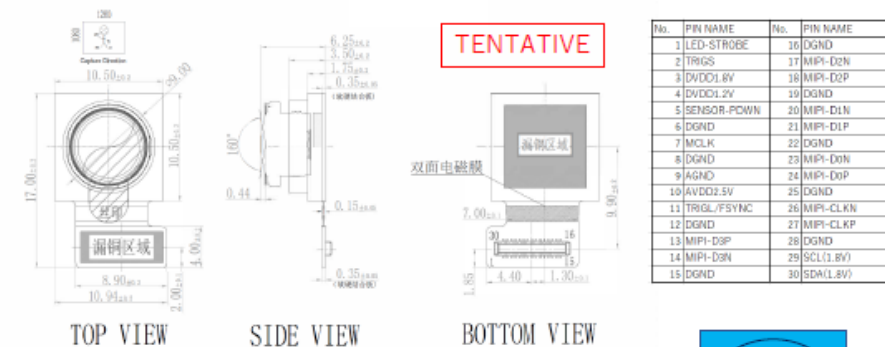

- Assumed application cases
- Wide vision for Robots of autonomous driving
 - O3D sensing with NIR structured light

Key Specifications		SE132GSFE160-00/01		
Image Sensor	Manufacturer	Smartsens Back-side illuminated, Global Shutter		
	Pixel size	2.7um x 2.7um		
	Active Image Area	1080 x 1280 1.3Mpix		
	Optical Size	Type 1/4 Diagonal 4.53mm		
	Operation Temperature	-40~85°C Function guarantee -20~60°C Performance guarantee		
Module	Maximum Frame Rate	120fps		
	Configuration	Type 1/6, 5P		
	FoV	160° ± (TBD)*		
	F No.	2.0 ± 5%		
	Focus range	30cm ~ Infinity, Adjusted at 80cm when shipped.(TBD)		
Board (option)	Connector	30pin	Compatible w/ Raspi Camera v2.1 module	
	Size	10.5*10.5*6.3mm(TBD)	Lens Holder size. 8.5 * 8.5 * 6.3mm by COB	
	Weight	0.4g(Tentative)		
	Power Supply	Analog	2.5V ± 0.1V	
		Digital	1.2V ± 0.06V	
IO		1.8V ± 0.1V		
Board (option)	Size	25mm* 24mm	Almost same size and compatible position for screw holes with RaspberryPi camera V2.1.	
	Connector	1.0mm pitch 15pin	For Tinker board, RaspberryPi	
		0.5mm pitch 22pin	RaspberryPi0, Raspi compute module, etc.	
	Output	I/O Format	Support MIPI CSI-2 2lane and 4 lane	
		Maximum speed	Full size: 120fps (MIPI 4 lane mode)	
	Power Supply	3.3V ± 0.3V	Generate Analog 2.8V by on-board LDO	
			Generate Digital 1.2V by on-board DD-converter.	
Generate Analog 1.8V by on-board LDO				
		Generate AF 2.8V by on-board optional LDO		

Why are the SE camera boards suitable for AIoT vision processing applications?

- Good image quality**
The SE camera series uses a high-quality image sensors of better SNR.
- Ready to use on tinker board and other SBCs**
Camera drivers are ready. Easy to customize for PoC prototyping
- Variety of Options**
Wide variety of options for resolution, global shutter, wide FoV lens, focus driver, etc.
- Low Latency, RAW image**
Suitable for real-time autonomous control system
- Affordable for everyone**
Pricing that individuals can purchase from a single item in line with the corporate philosophy of *helping to create open innovation.*

Further Information:
<https://soho-enterprise.com/>
<https://www.visionproc.org/index.php>

汎用カメラモジュールシリーズ SEI012FF-D, SEI012FFW-D

ISP内蔵型5Mpixイメージセンサーを使ったレンズモジュール。
DVPインターフェースタイプから順次発売予定

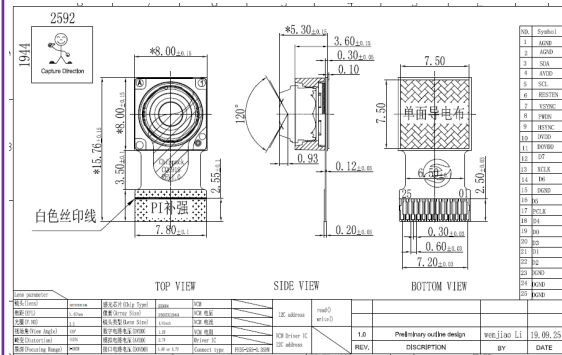

イメージセンサ	
センサタイプ	1/4型 CMOSイメージセンサ
有効画素数	511万画素
記録画素数	504万画素
カメラ制御	
ISO感度	ISO 40~800
シーンセレクト ション	12パターン
露出制御	自動、シャッター優先、ISO感度優先、長時間AEモード
測光モード	マルチパターン、中央重点、画面全体平均、スポット
露出補正	±2EV、1/3EVステップ
シャッタース ピード	1/8 s (長時間AEモード) ~1/42000 s
ホワイトバ ランス設定	オートホワイトバランス、太陽光、曇天、蛍光灯、ランプ
フォーカス制 御	オート、シングルAF、連続AF、マニュアル
画像フォー マット	
出力画像フ ォーマット	JPEG (4:2:2)、Y/Cb/Cr、YUV、RGB、RAW、JPEG+YUV (サムネイル)
静止画デー タレート	5M pixel 15 frame/s JPEG output
動画デー タレート	SVGA 30 frame/s YCbCr output
HDビデオ出 力	1080p (1920×1030 30 frame/s)、720p (1208×720 60 frame/s) JPEG output、JPEG+YCbCr output

魚眼タイプ : SEI012FE-D (FoV=160° and/or 187°)
AFタイプ : SEI012AF-D(76°), SEI012AFW-D(120°)
ラインアップに追加していきます。

SE-SB02基板に接続可能なMIPI IFバージョンも開発受注可能

1Mpix UVCカメラ (M12レンズタイプ)

SE9732USB

Omnivision社製イメージセンサーOV9732を採用

1/4”型、3.0um画素、1,280x720の高感度汎用UVCカメラ基板です。

カスタム光学フィルタの取り付け応談

M12マウントで様々なレンズと組み合わせが可能です。

小型モジュール化を検討中。(FoV=76°、120°、150°、160° 魚眼)

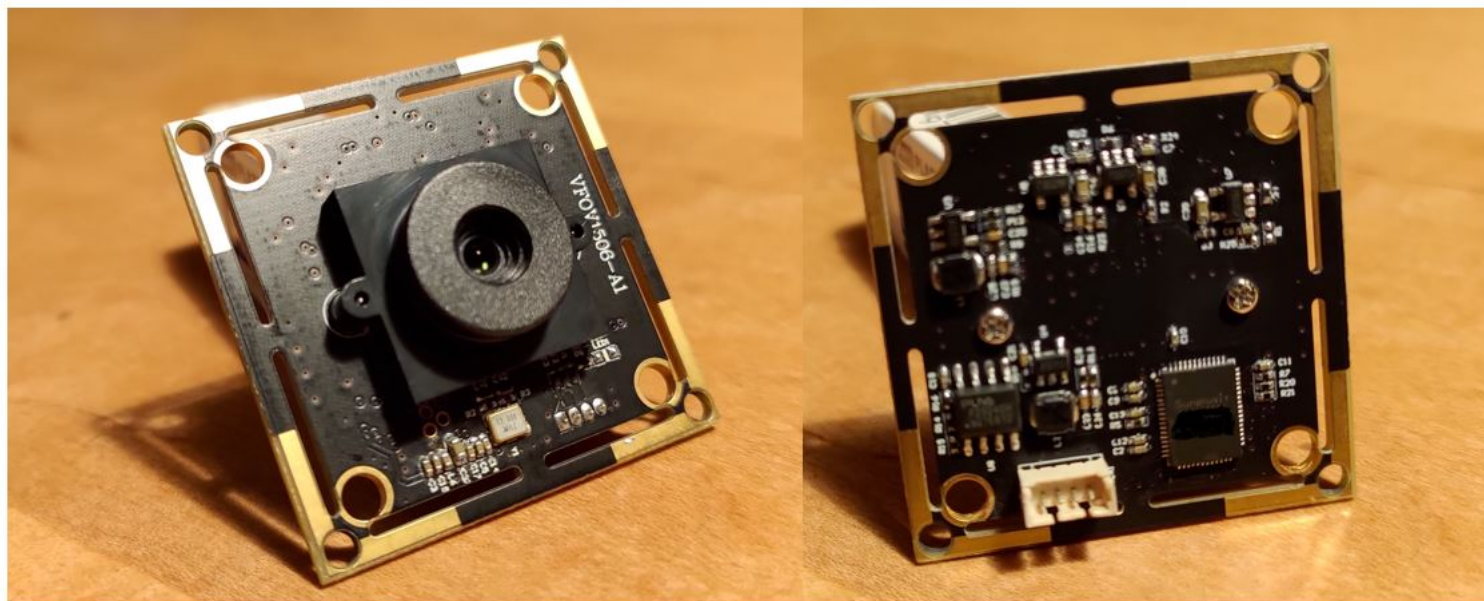

OPNOUS Full Product



GENERAL DESCRIPTION

OPN8001/8008/8018 are Time-of-Flight (ToF) imaging sensors for 3D sensing covering 100x100 / QVGA (205x245) / VGA (640x480) level matrix sensing resolution. The 3D sensing is realized upon 850 nm and 940 nm NIR wave length with an industry leading accuracy. The power consumption achieves the lowest power level in the industry, which benefits many portable and energy saving applications. OPN8001/8008/8018 are developed as key products of OPNOUS ToF solutions for a broad range of applications.



GENERAL DESCRIPTION

The OPN7007 is a smart VCSEL laser diode driver with high performance and high efficiency, which is optimized for Time of Flight (ToF) camera application. It is embedded with configurable current limit function to output specific peak current for illumination. A 12-bit ADC is also integrated for eye protection and temperature monitoring. The OPN7007 supports PC interface configuration.



FUNCTIONAL DESCRIPTION

OPN6001 is a high performance, low power, low cost application processor (dedicated for ToF sensor). It is embedded with a sophisticated ToF ISP covering the ToF raw data to user space distance in 4K day. With its novel self-cleaning engine, it also automatically turns lights and sensors to get best image with different scenarios. A 30MHz ARM Cortex-M3 processor is also integrated to handle system controlling and on-line operations. It can support up to 3 ToF sensors simultaneously with 800-1024 resolution, range different sources and transmit the data to host AP by USB, DV, the CSI or MIPI CSI interface.



FUNCTIONAL DESCRIPTION

The OPNE8008B is our Evaluation Kit for the QVGA OPN8008B Time-of-Flight (ToF) Sensor. This Evaluation Kit is fully assembled and tested camera system designed for the evaluation of the OPN8008B QVGA ToF Sensor, which provides all necessary hardware to operate OPN8008B, including both the camera lens and illumination. It can be directly connected to a PC for real-time visualization and recording of depth map data, while allowing direct access to many configuration settings. The system is fully controllable by an intuitive GUI on a PC.



GENERAL DESCRIPTION

Opnus provides a series of Time-of-Flight (ToF) imaging modules fitting for a broad range of 3D sensing applications. These 3D sensing modules are realized upon 850 nm and 940 nm NIR wave length with an industry leading accuracy. The power consumption achieves the lowest power level in the industry, which benefits many portable and energy saving applications.

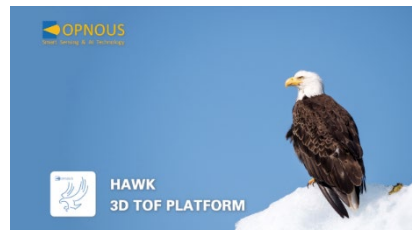

GENERAL DESCRIPTION

Hawk 3D ToF platform consists of OPNOUS ToF sensor OPN8008, VCSEL driver OPN7007 and ToF ISP OPN6001. It has built-in high performance, low power consumption ToF signal processing features -- auto-exposure(AE), high dynamic range(HDR), spatial and temporal de-noise and multi-device interference immunity. Hawk 3D ToF platform provides an easy-to-integrate ToF 3D vision solution for mid and long range applications.

Hawk 3D ToF platform can connect to host computer via USB 3.0 UVC protocol. Its SDK supports Windows and Ubuntu on x86 architecture.

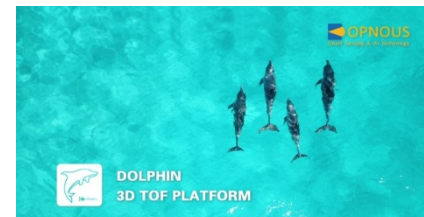

GENERAL DESCRIPTION

Dolphin 3D ToF platform consists of OPNOUS ToF camera module and ToF ISP chip OPN6001. Dolphin has built-in high performance, low power consumption ToF signal processing features -- auto-exposure(AE), high dynamic range(HDR), spatial and temporal de-noise and multi-device interference immunity.

Dolphin 3D ToF platform can connect to embedded application processor via MIPI interface or to computer via USB 3.0 UVC protocol. Dolphin SDK supports Windows and Ubuntu on x86 architecture and embedded Linux on embedded ARM processors.

Dolphin 3D ToF platform provides an easy-to-integrate ToF 3D vision solution for 3D applications within 5-meter range, such as facial recognition, machine vision, SLAM, 3D re-construction, AR/VR, etc.



OPNOUS ToF Camera



[中文](#)
[English](#)
[Japanese](#)
[タオバオの店舗](#)
[Seed](#)
[ニュースセンター](#)
[採用情報](#)
[お問合せ](#)

[製品](#)
[アプリケーション](#)
[サポート](#)
[企業情報](#)

検索する製品名を入力してください:



実用に優れ、リーズナブルな価格のOPNOUS社ToF Solutionを提供

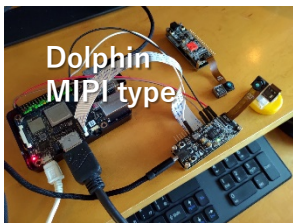

ToFシステムプラットフォーム

現在の位置です: [トップページ](#) > [製品](#) > [ToFシステムプラットフォーム](#)

Part NO	Category	Resolution	FoV	Range	IR Filter	Interface
OPNCAM8508C/197-1MA-UA	Dolphin	320x240	72x55	1m/2m	940nm	USB 3.0
OPNCAM8506A/58C-1MA-UA	Dolphin	320x40	110x10	5m	850nm	USB3.0
OPNCAM8508C/197-1MA	Dolphin	320x240	72x55	1m/2m	940nm	MIPI
OPNCAM8506A/58C-1MA	Dolphin	320x40	110x10	5m	850nm	MIPI
OPNCAM8008A/588-1MA-UA	Hawk	320*240	86x68	5m	850nm	USB 3.0
OPNCAM8008A/598-1MA-UA	Hawk	320x240	86x68	5m	940nm	USB 3.0
OPNCAM8008A/58B-1MA-UA	Hawk	320x240	110x90	5m	850nm	USB 3.0
OPNCAM8008A/59B-1MA-UA	Hawk	320x240	110x90	5m	940nm	USB 3.0
OPNCAM8008A/A92-1MA-UA	Hawk	320x240	24x18	10m	940nm	USB 3.0

Software



<http://www.opnous.com/jp>