



Innovation for Innovators

# Camera Module Product Line-up Aug.2022(Rev.02)

双峰エンタープライズ株式会社  
Soho Enterprise Ltd.

2022.8 New Release

High Sensitivity Camera w/ Sony IMX462 (STARVIS)  
Compatible to IMX290 (officially supported by libcamera)

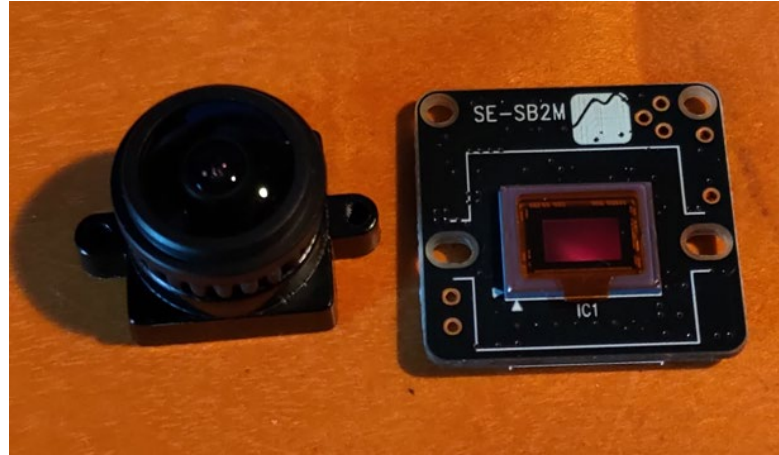

Better sensitivity than IMX290

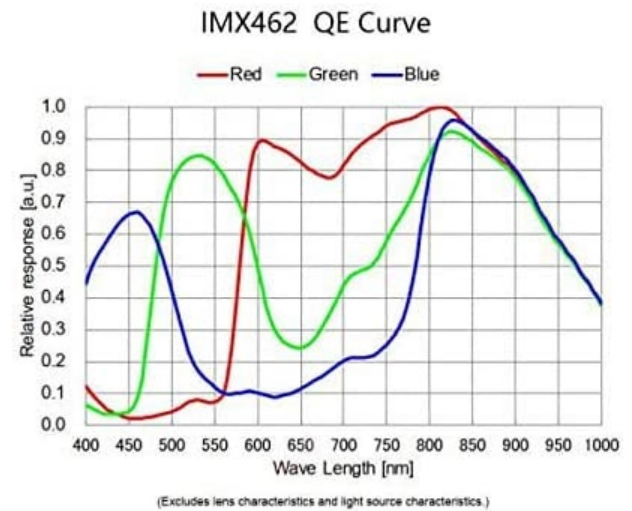

2022.8 New Release

# High Sensitivity Camera w/ Sony IMX662 (STARVIS2)



**SE-SB2M-IMX662**

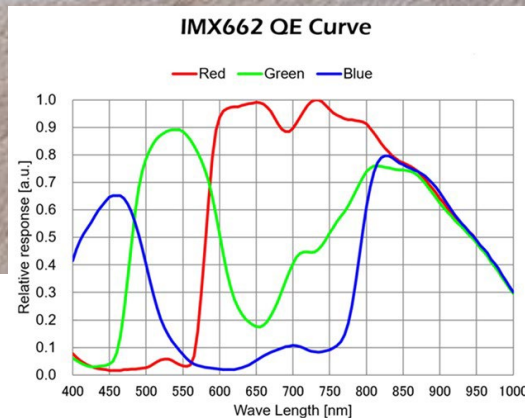
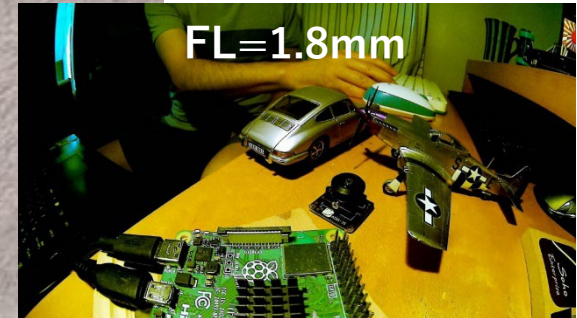
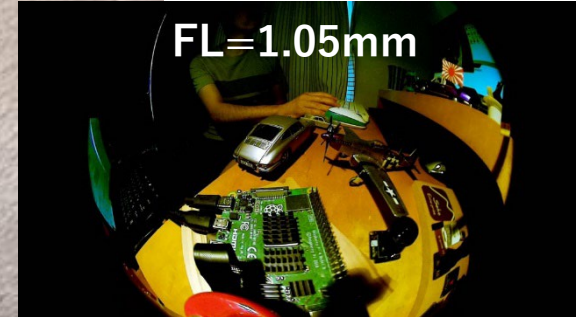



2022.8 New Release

SE-SB03 board for 12Mpix IMX477/577 camera module

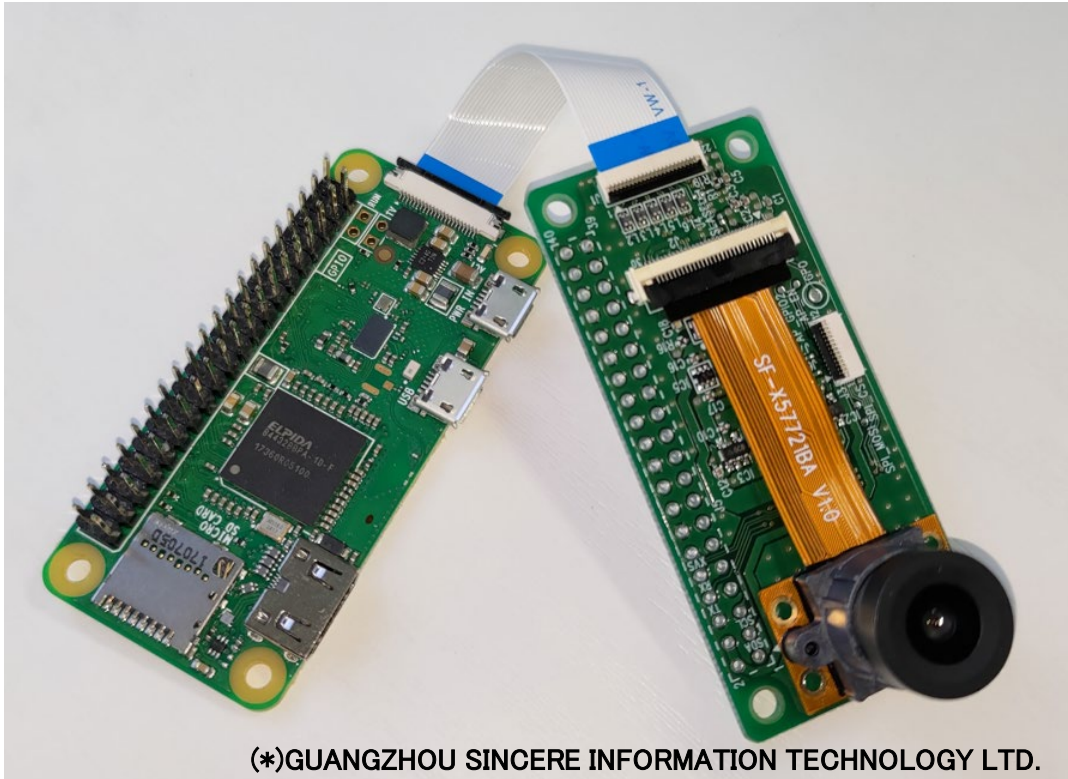

Connection board for SF-X47721BA/SF-X57721BA camera module(\*)

Expecting the HQ-camera equivalent performance With small form factor.

(\*)GUANGZHOU SINCERE INFORMATION TECHNOLOGY LTD.





Jan. 2022 New Release

# RGB-D evaluation Kit “SE-ROBD-EVK”

OPNOUS ToF system=OPNS3031A + SE camera board

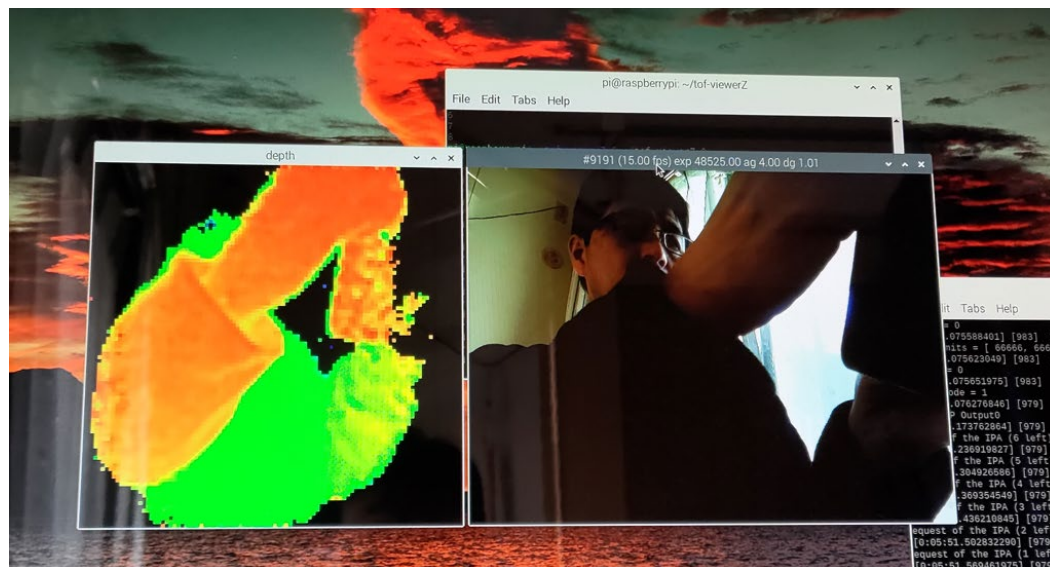

OPNOUS社製品情報

<http://www.opnous.com/jp>

<http://www.opnous.com/jp/product/index/id/142.html>

RGBカメラは弊社SEカメラボードのラインアップから選択可能です。  
Ex. SE219FFW, SE219FE160, SE327MBD, ...

# 2021.5 New Release ③

## OPNOUS Dragonfly Demo Kit Stand alone depth solution

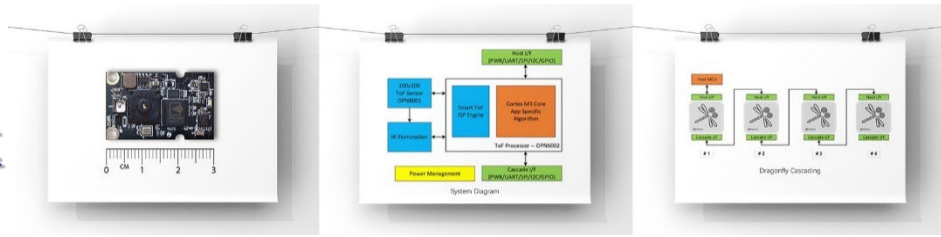

IR wave length (nm)	850 or 940
ToF resolution	Max 100 x 100
FoV (degree, H x V)	70 x 70
Accuracy	2%, typical
Frame rate (FPS)	up to 60
Power supply (V)	5
Communication Interface	UART/I2C/SPI/GPIO
Size (mm^3)	30 x 19 x 3.98

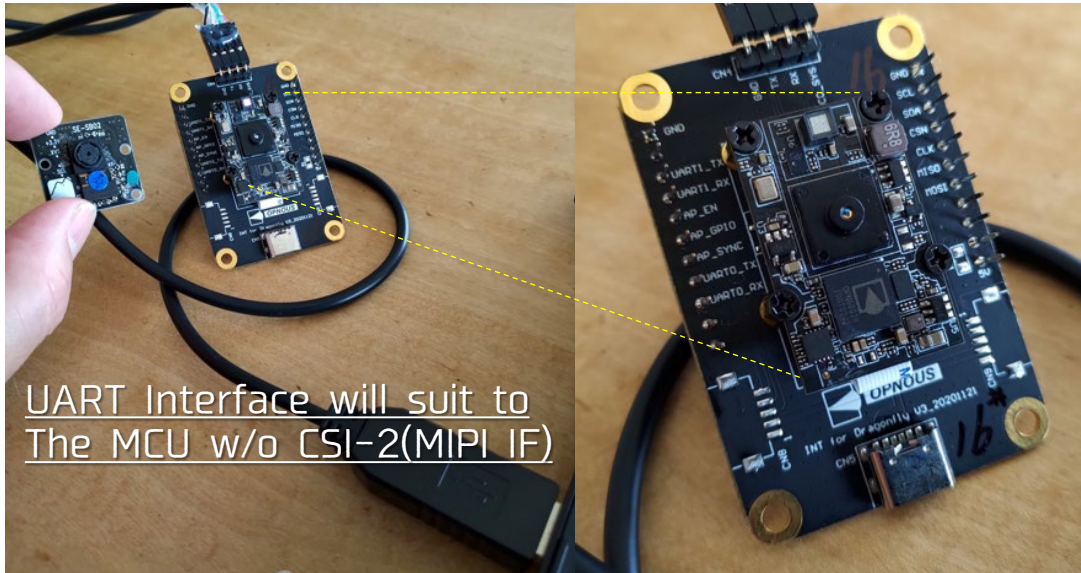

UART Interface will suit to  
The MCU w/o CSI-2(MIPI IF)

The screenshot shows the 'Dragonfly' software interface. It features a 'SerialPort' tab with a 'Depth' visualization showing a hand in a heatmap. The interface includes control buttons like 'Close Serial', 'Init Dragonfly', and 'Start'. A 'Statistics' section shows 'IR Depth: 1088.20' and 'FPS: 2'. A 'Log' section at the bottom displays system messages.



2021.6 New Release ④

# Full HD High Sensitivity Camera w/ Sony IMX327

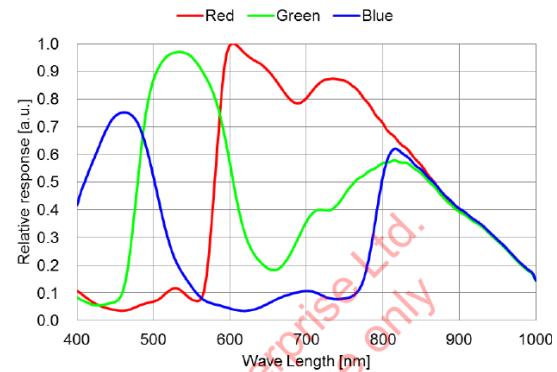
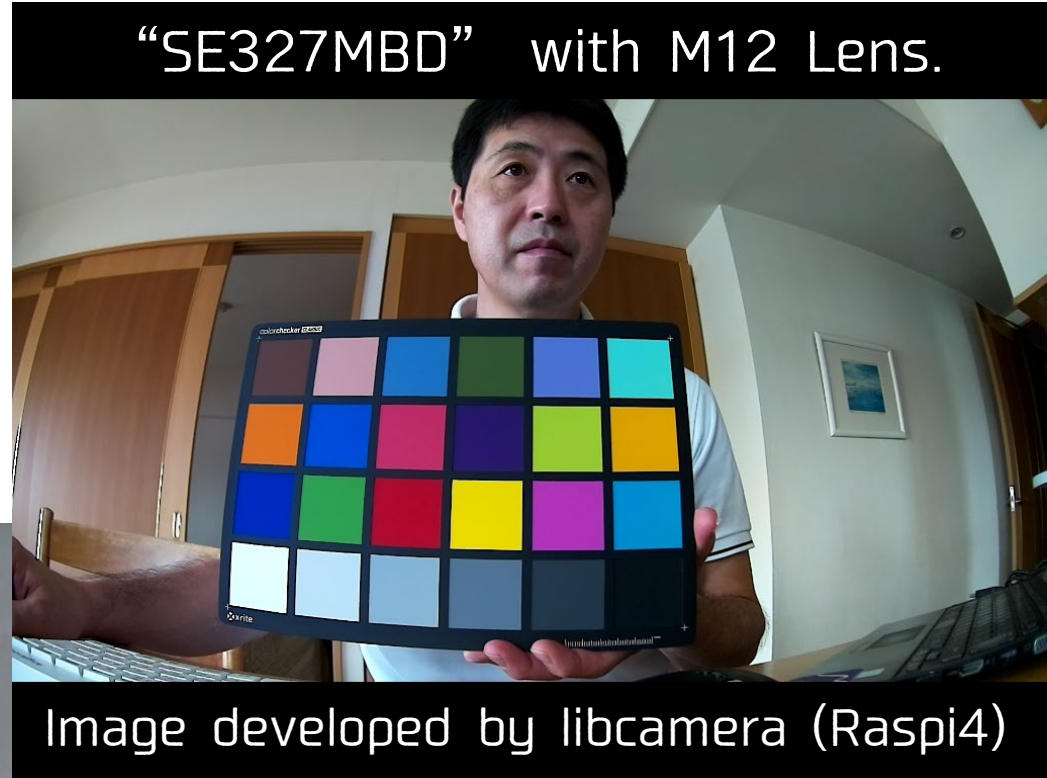
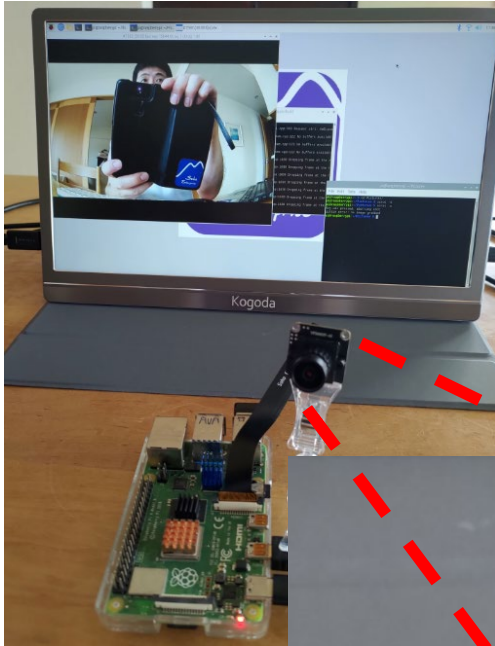



*Now ready for Sample delivery!*



Driven on RaspberryPi w/ libcamera-apps

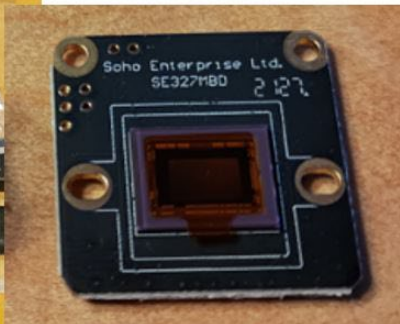

- 1920x1080 Full HD with 30fps on Raspi.
- Excellent Image Quality by 2.9um $\square$  pixel
- Various Lens can be applied

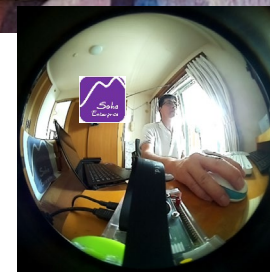

Image developed by libcamera



Full HD 30fps, FoV(D)=140°

SE327MBD + SE-CXB01(FPD Link III) + libcamera + OpenCV(face detection)



SE-CXB01 (FPD Link III) Camera Extension Board

# SE327MBD High Conversion Gain Mode

Captured by in-house RAW capture App.

(※Short exposure time, No gain applied to see the difference.)

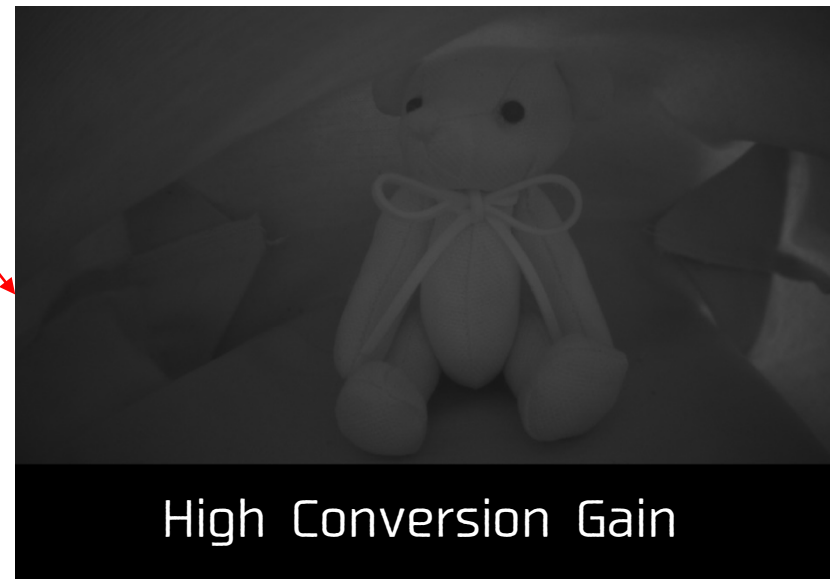
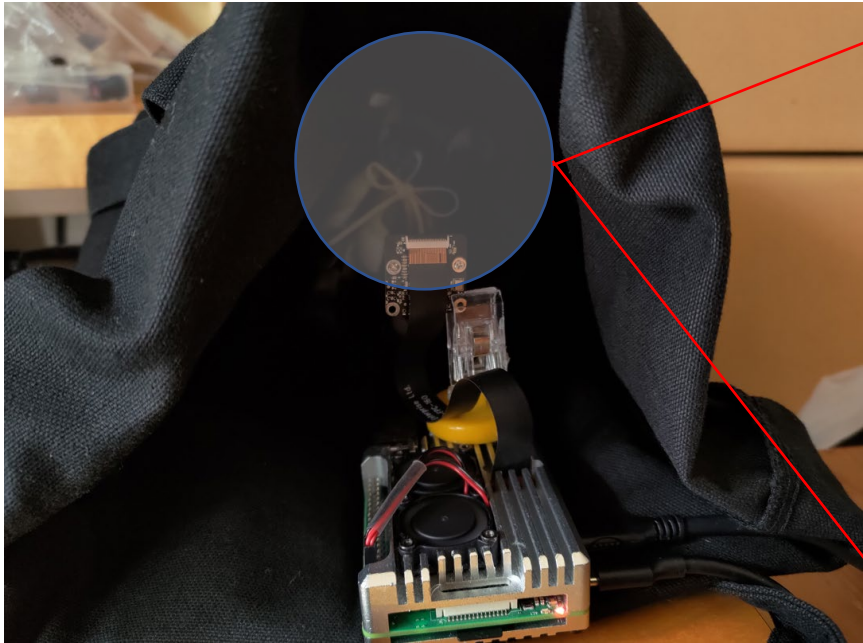



# 2021.6 New Release ①

## Tiny 4K camera on RaspberryPi

### “SE258AF120” Lens Module of FoV(D)=120° with VCM Focus Driver

IMX258 is the 13Mpix 1.12um pixel Sensor from Sony. We have made the imx258.c camera driver, libcamera related files, and now we can see the image processed by ISP.

We will implement the focus driver command soon.

Many lens option including SE258PKG will be launched soon.

SE258AF120-00-CB02

Almost the same size to IMX219 module

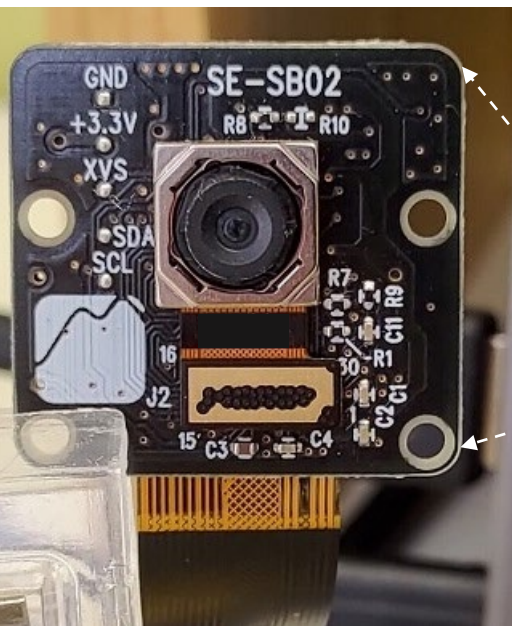
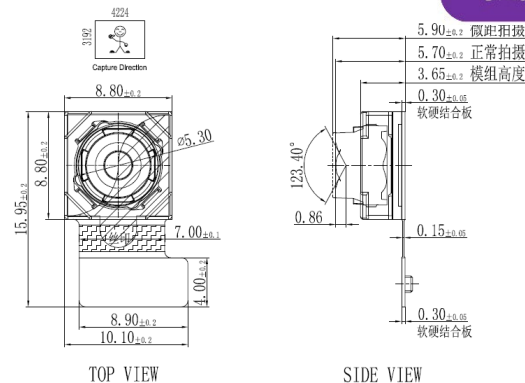



2021.6 New Release ②

Tiny 4K camera on RaspberryPi



“SE258PKG-01” Lens-less module w/ cover glass

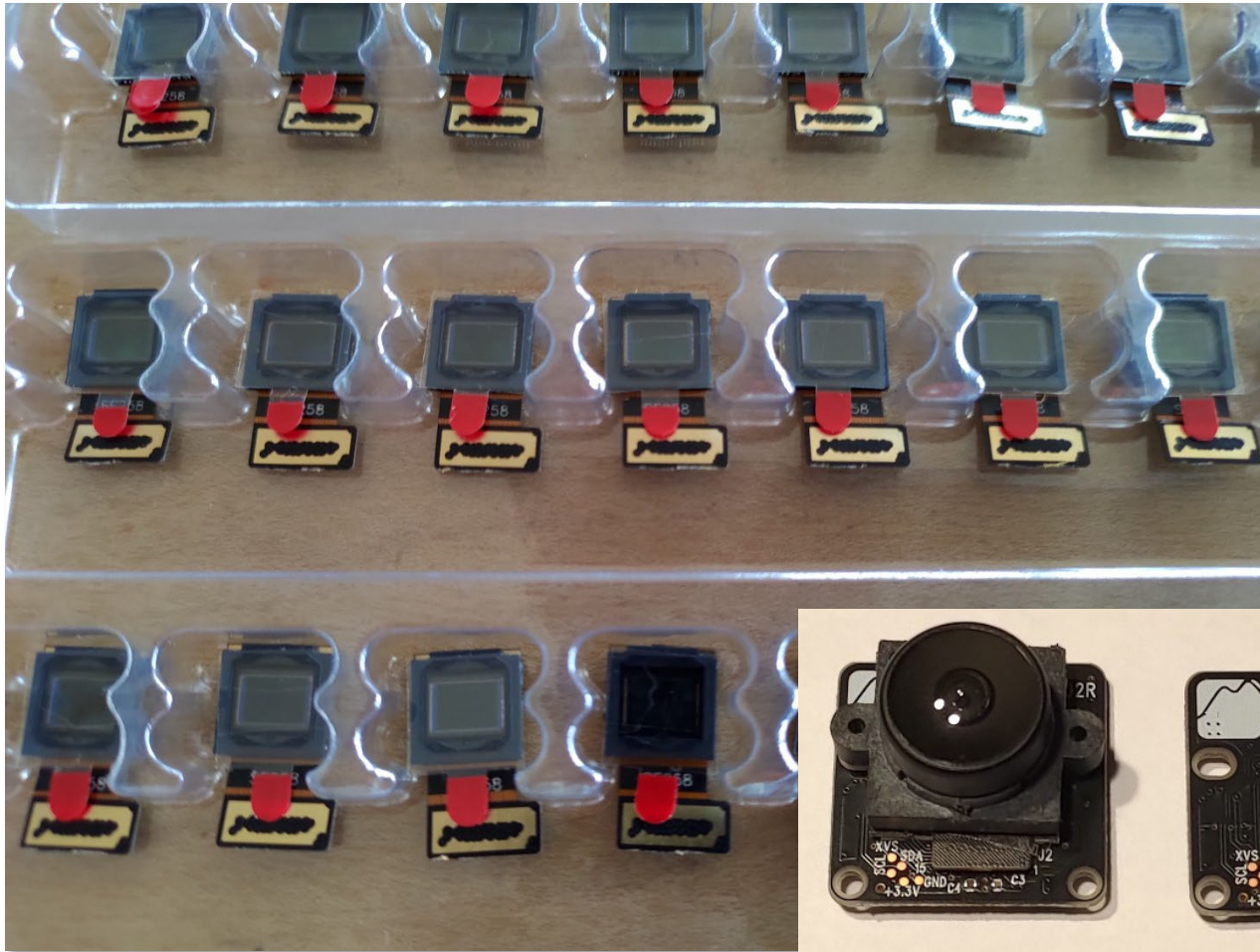

Many of M12(or other size) lens option can be attached by SE-SB02R

2021.6 New Release ③

1.3Mpix Global Shutter sensor module



“SE132GSPKG-01” Lens-less module w/ cover glass

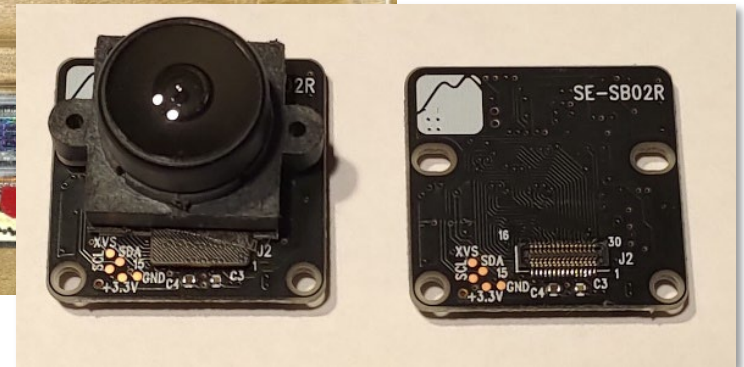
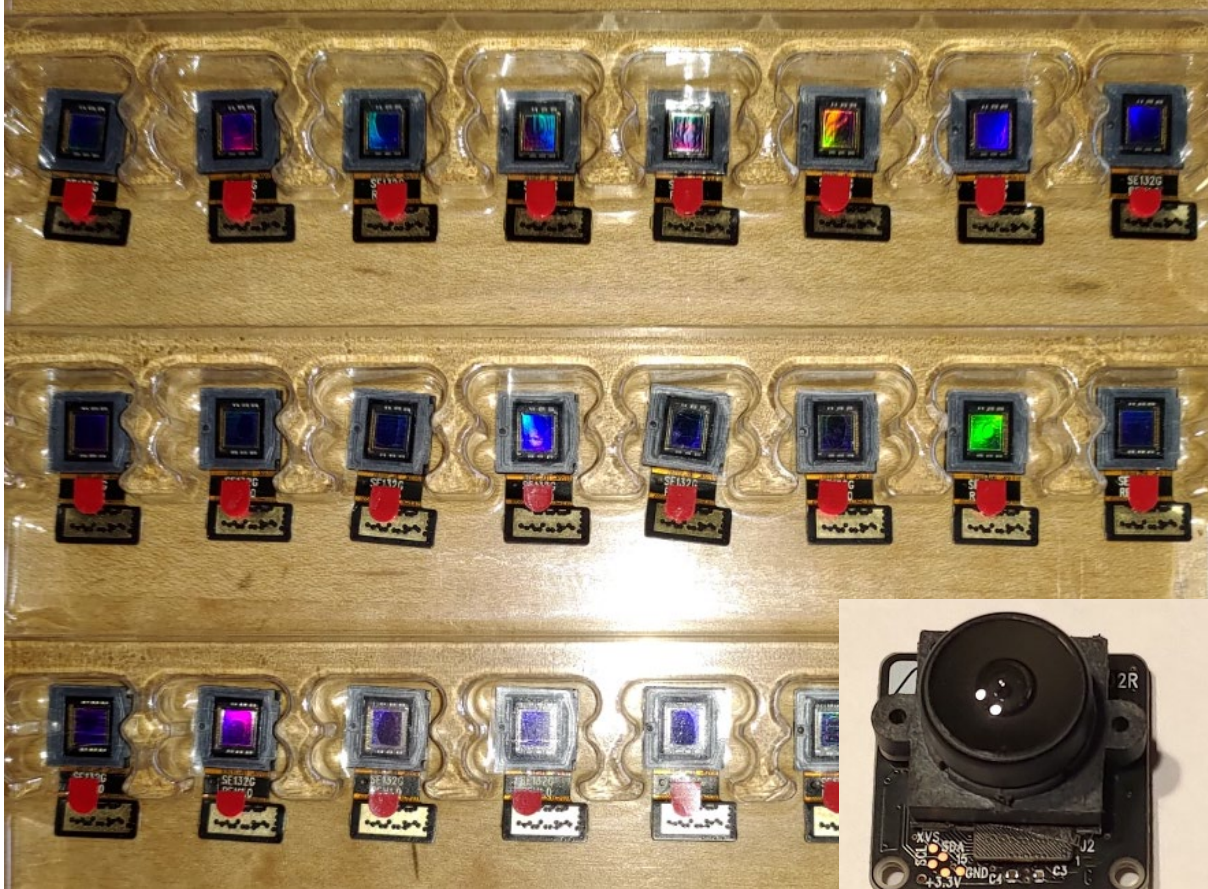

Many of M12(or other size) lens option can be attached by SE-SB02R



# OPNOUS ToF Solution with high-speed ISP ASIC on Raspi4 Ubuntu20.04



Dolphin ToF Platform is working on RaspberryPi4 (OS: Ubuntu20.04)  
On board ISP realizes “easy to launch the ToF solution” on the most popular SBC.

MIPI camera version is also available.

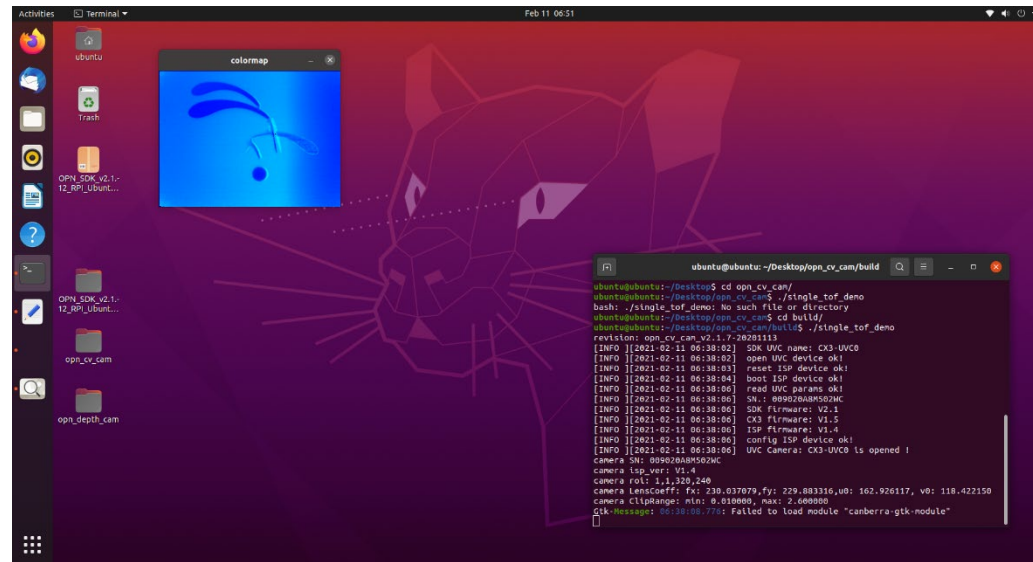
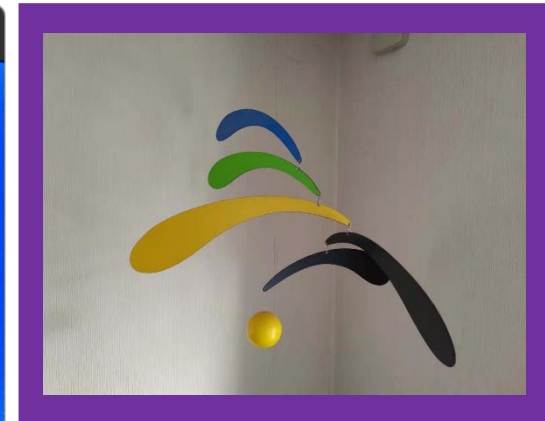
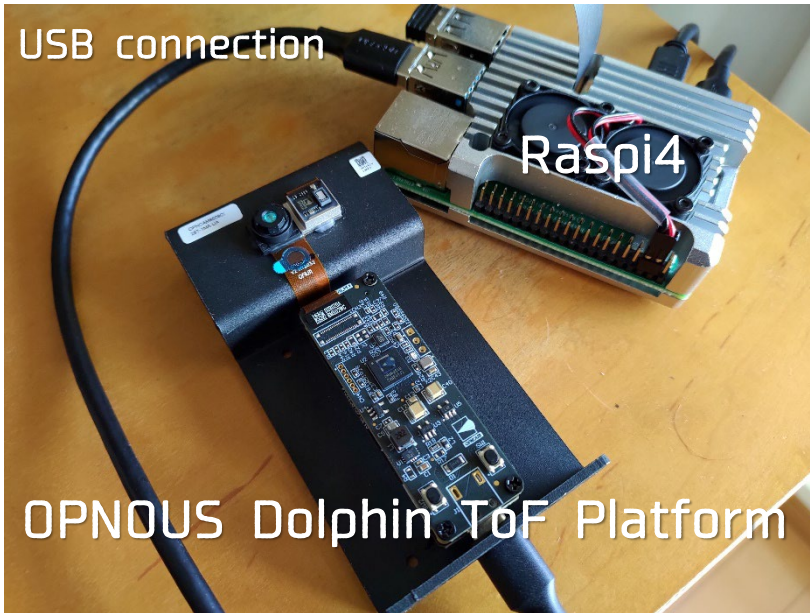



# 2021.2 New Release ①

## SE219FF88 & SE219AF88 FoV(D)=88degree wide angle module

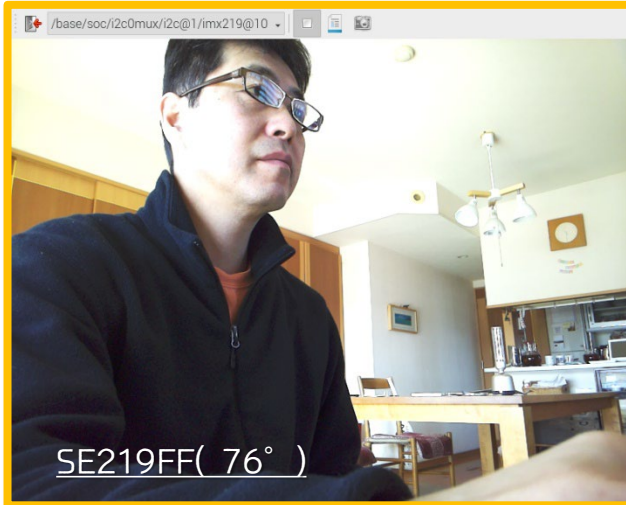
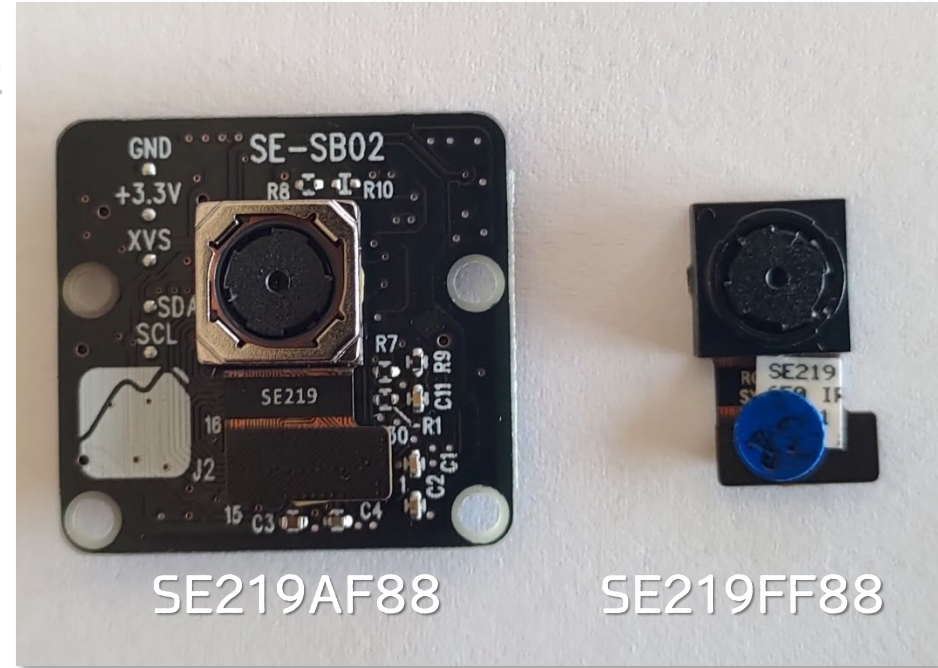
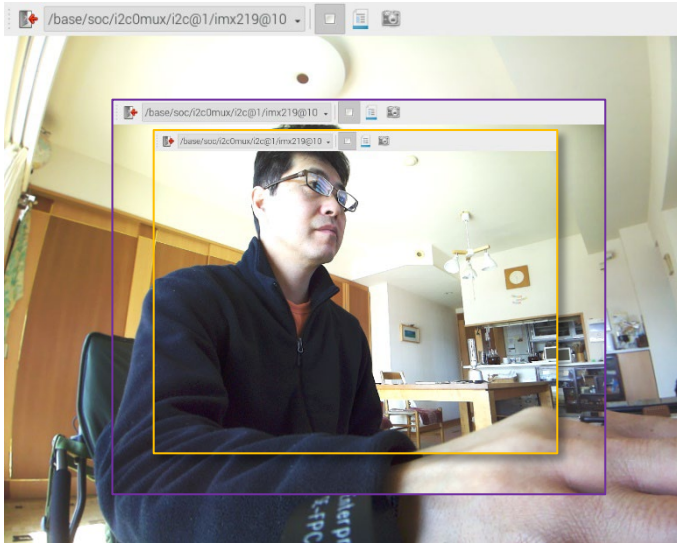

## 2021.2 New Release ②

### SE219PKG-00/01 and SE-SB02R M12 lens holder attachable camera board

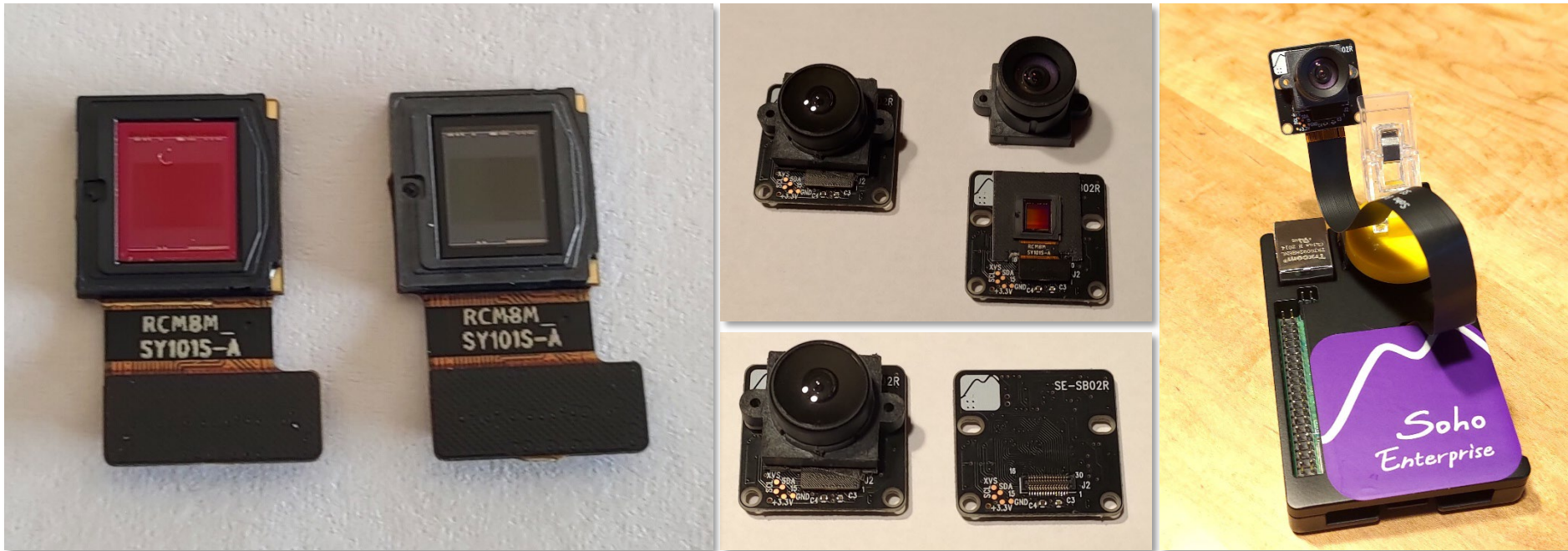



# SBC向け小型レンズモジュール：SE219シリーズ 画角比較

新たに対角150°の広角モジュール「SE219FF150-00」が  
ラインアップに加わりました。

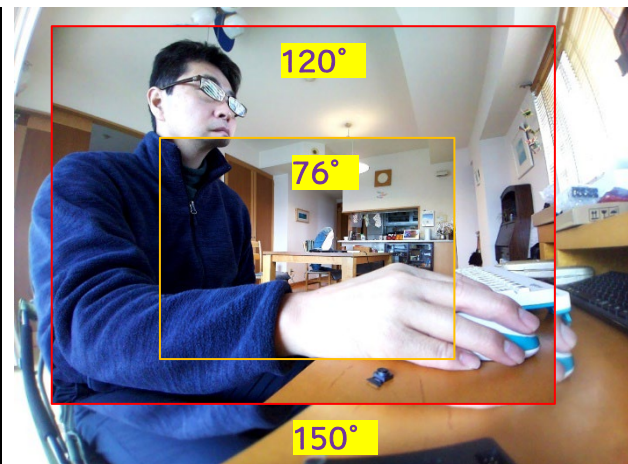
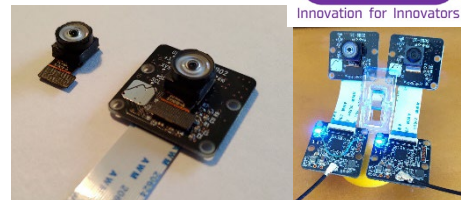



# SBC向け小型レンズモジュール：SE219シリーズ ステレオ3Dカメラ応用例

76°



Base Line 65mm



Base Line 85mm

fx:1777 vx:160 w: 0.143 G:118 R:122

150°

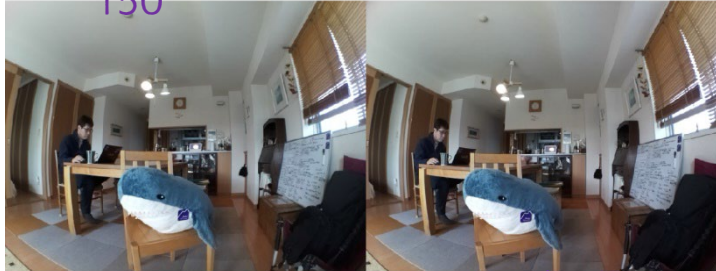

Base Line 65mm

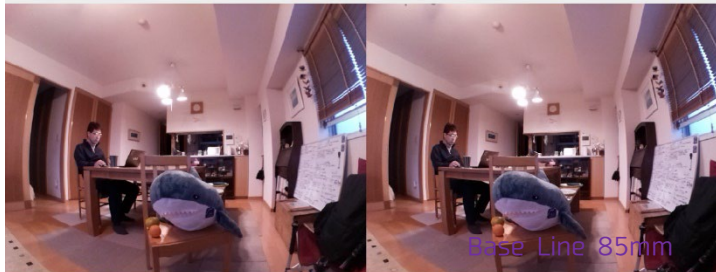

Base Line 85mm

fx:967 vx:16 w: 0.182 G:149 R:151

120°

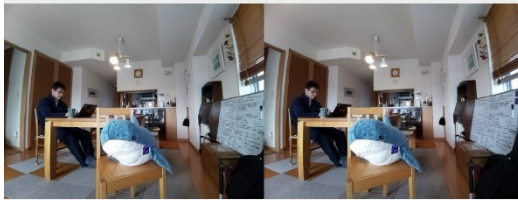

Base Line 65mm



Base Line 85mm

fx:1798 vx:150 w: 0.181 G:178 R:180

160°



Base Line 65mm



Base Line 85mm

fx:1700 vx:200 w: 0.151 G:187 R:197

187°



Base Line 65mm



Base Line 85mm

fx:1670 vx:160 w: 0.111 G:180 R:180



# SE-CXB01-Tx/Rx FPD LINK III MIPI EXTENTION BOARD

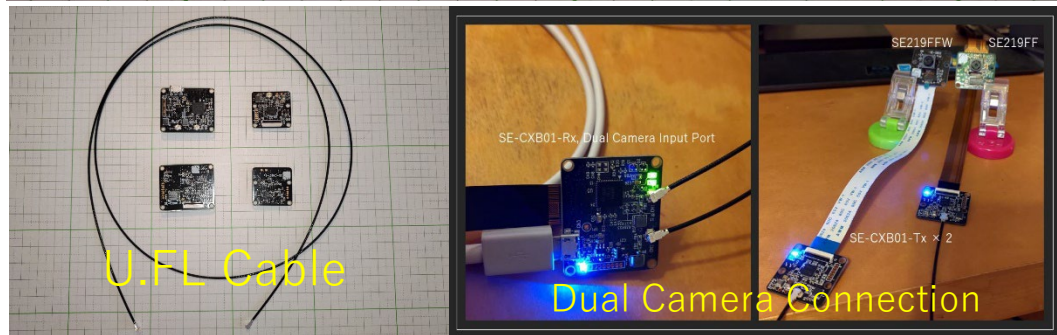
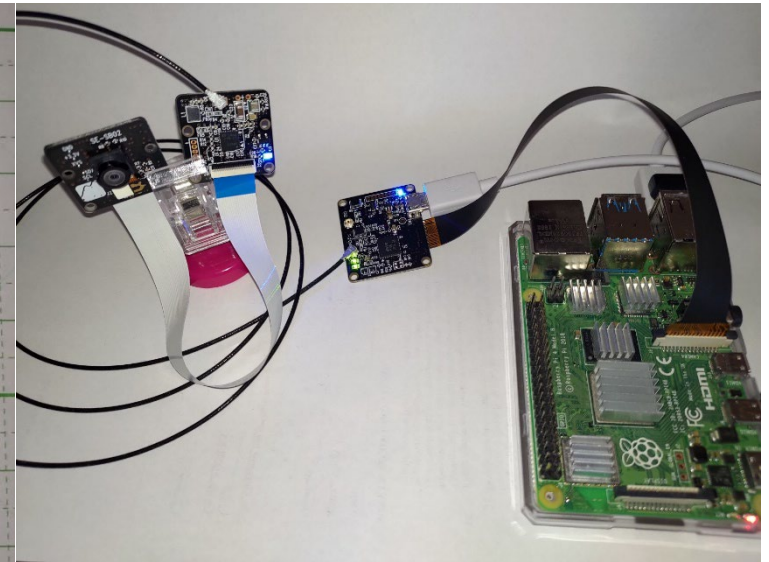
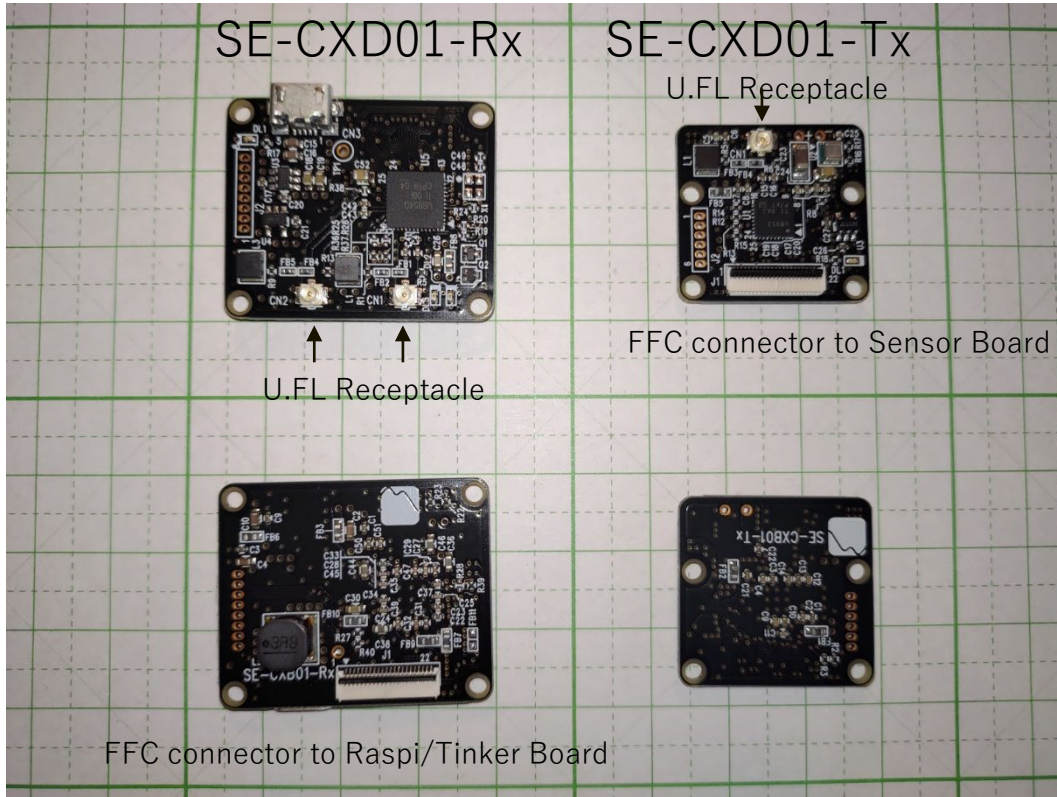



# SE219FFW-00/01 and SE132GSW-01 FoV=120° 品のサンプル出荷開始

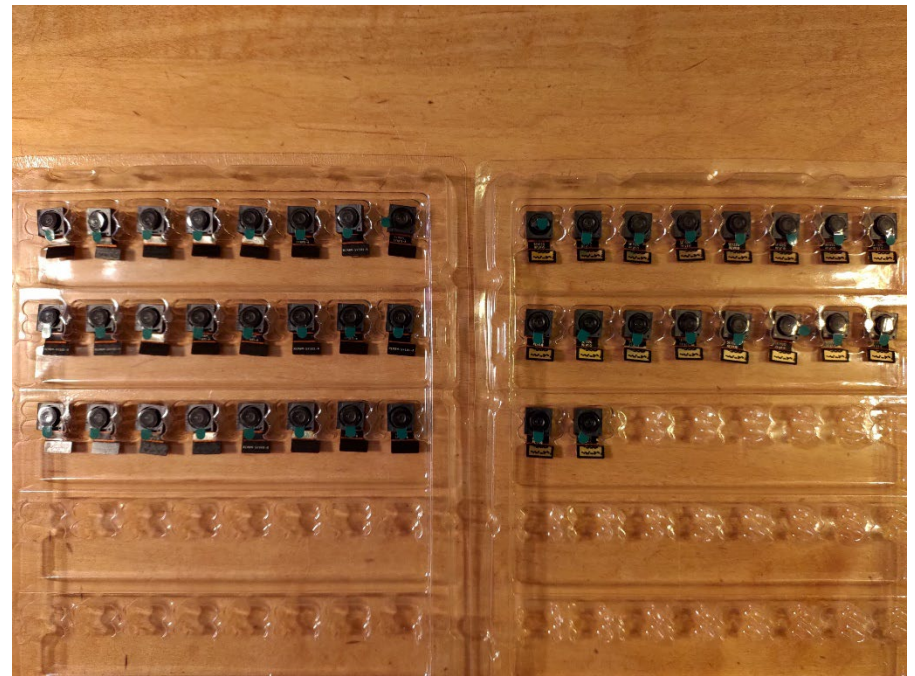
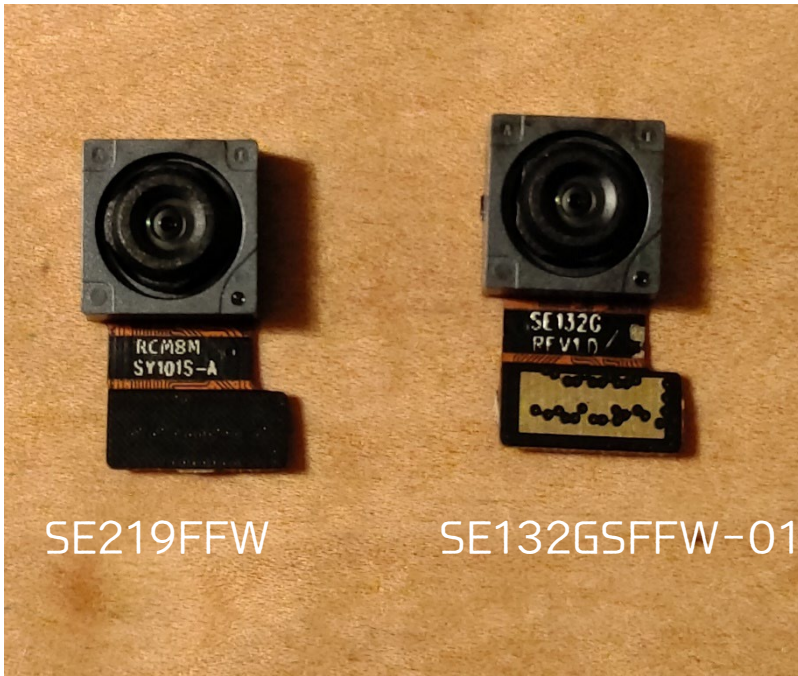

## FoV(Field of View) comparison SE219FF & FE219FFW



重ねて  
比較



# Vision System向けイメージセンサーモジュール SE219FE-00-CB (w/ IRCF), SE219FE-01-CB (w/o IRCF)

あのIMX219が(x, y)投影サイズそのままにFoV=187°の魚眼カメラになりました。

しかも厚みは6mm以下。狭い場所に仕込むことができます。  
従来製品(対角76°)に対し圧倒的な情報量の画像取得が可能です。

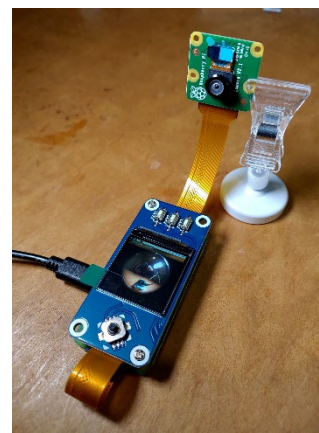
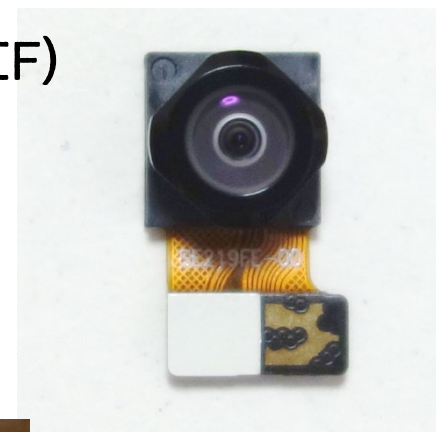

バンダイ様の人気商品  
ガシャポンのザクヘッドに  
ぴったり収まります。

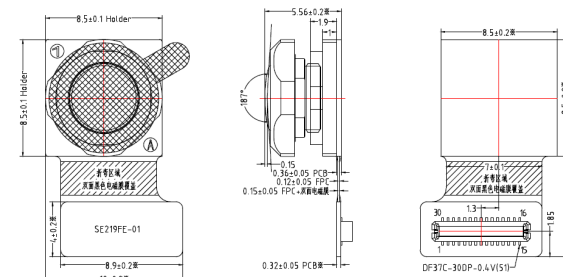





Soho Enterprise Ltd.

Fish Eye Camera Board w/ 8Mpix CIS for Single Board Computers

SE219FE-00/01-CB



Ultra Wide View Angle: FoV = 187° ± 3° Suitable for wide angle image recognition usage in AIoT area.

Adopted the most mature image sensor for SBC. Sony IMX219PQH5-C

Camera Driver with AE/AWB functions for "tinker board" is available. Processed in Embedded HW ISP. Full Size 20fps/FHD 30fps

w/ IRCF(-00), w/o IRCF(-01) modules are available

Extensivity: FFC connector for MIPI CSI-2 4 lane connection for faster fps.

Ready for use No need remodeling the module to get wide FoV

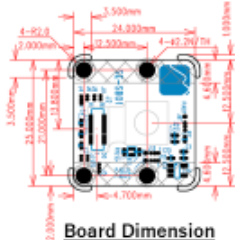

Board Dimension

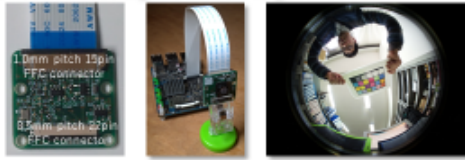

Assumed application cases

- Look down monitoring with few blind spots
VR Stereo Vision
Wide vision for Robots, AI speaker, any others
Monitoring wildlife ecology, ham to agriculture
Home-use video monitoring & recording
360° monitoring on drones, robot cars, etc.
Sports camera for tennis, volleyball, badminton, etc.

Fish Eye Lens Module: SE219FE-00/01

Table with 4 columns: No., Part Name, Part No., Part Name. Lists components like lens, sensor, driver, and board.

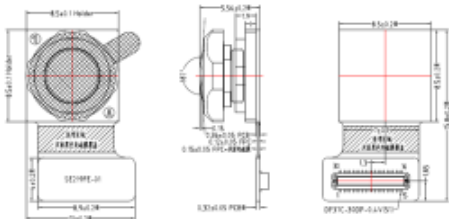

Pin assignment table with columns: No., Pin Name, No., Pin Name. Lists electrical connections like NC, DVDD, AVDD, MIPI signals.

Same (x, y) form factor & compatible pin assignment w/ the module on Raspberry Camera V2.1

Ver. 1.1.0

Key Specifications SE219FE-00/01-CB

Table of key specifications for the SE219FE-00/01-CB camera board, covering Image Sensor, Lens, Module, Board, and Power Supply details.

Why are the SE camera boards suitable for AIoT vision processing applications?

- 1. Good image quality: The SE camera series uses a high-quality Sony image sensors of better SNR.
2. Ready to use on tinker board and other SBCs: Camera drivers are ready. Easy to customize for PoC prototyping
3. Variety of Options: Wide variety of options for resolution, global shutter, wide FoV lens, focus driver, etc.
4. Low Latency, RAW image: Suitable for real-time autonomous control system
5. Affordable for everyone: Pricing that individuals can purchase from a single item in line with the corporate philosophy of helping to create open innovation.

Further Information:

https://soho-enterprise.com/
https://www.visionproc.org/index.php



Ver. 1.1.0

# 魚眼カメラ応用事例：detect\_cat（アプリSW配布中。）

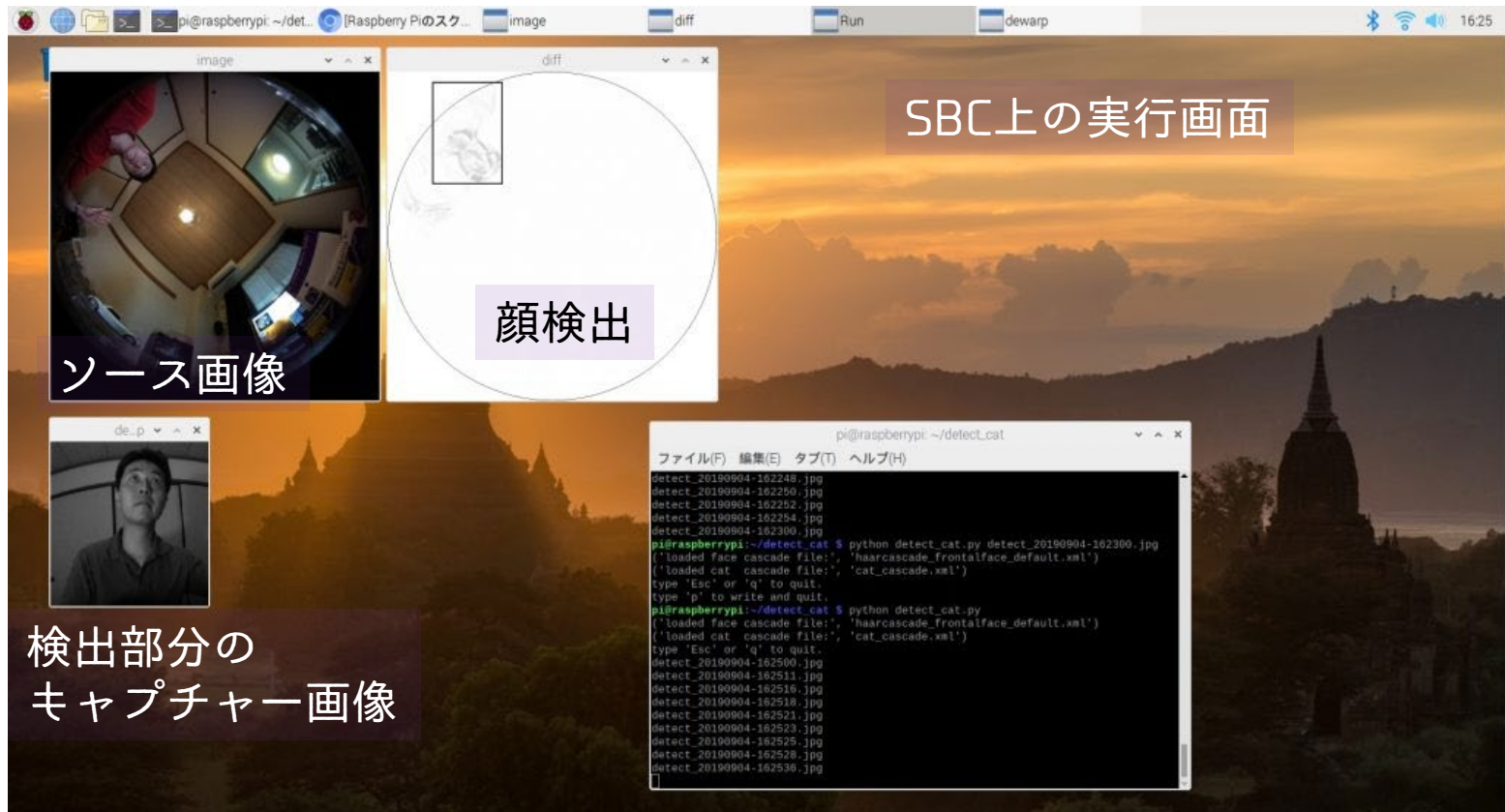



# 魚眼カメラ応用事例：魚眼スポーツカム

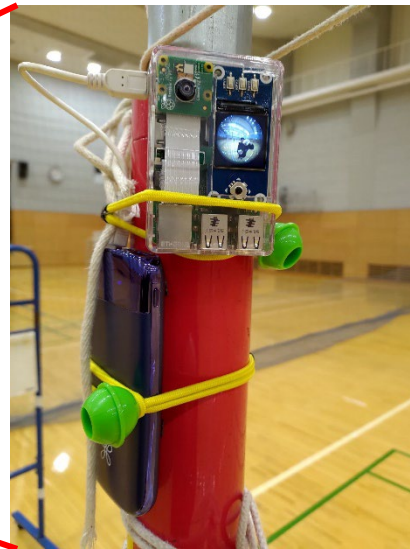
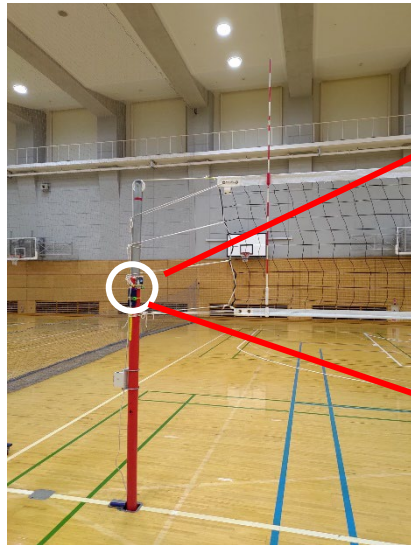

# 広角レンズモジュールのVision Processing適用事例

認識系アプリ



Coyote Racer

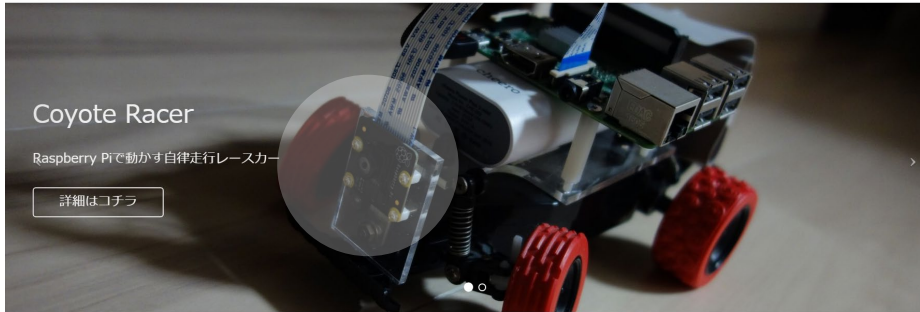

測距系アプリ

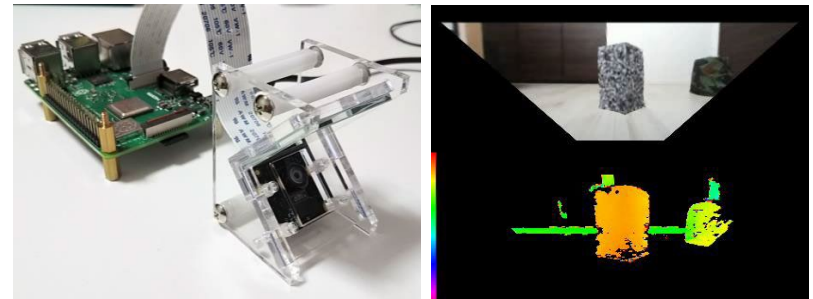

超広角応用ステレオ測距

Line laser depth module

FoV~135deg  
Processing time~15ms/frame

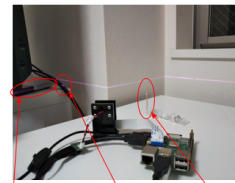

plastic TV stand @26 cm  
cable @26 cm  
tooth pick @10 cm

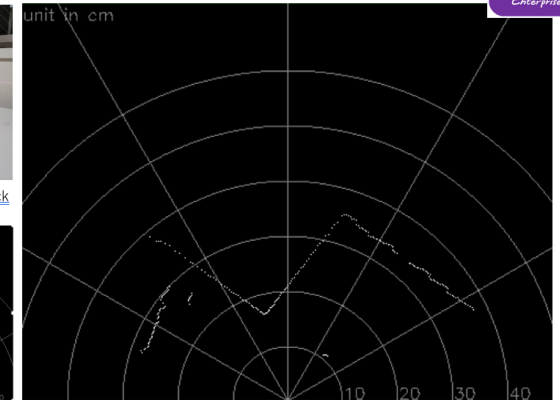
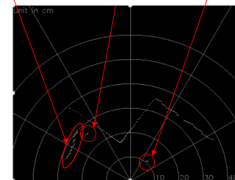

CQ出版社 Interface  
2020年3月号に特集記事掲載→



ラインレーザー+単眼ステレオ測距  
132° 広角レーザーとの組み合わせ



FoV=120° 固定フォーカスカメラ

SE219FFW-00-CB (w/ IRCF), SE219FFW-01-CB (w/o IRCF)

想定適用例：広角3D動画、顔認識、ドアホン、見守り監視、自律移動ロボットのセンシングなど

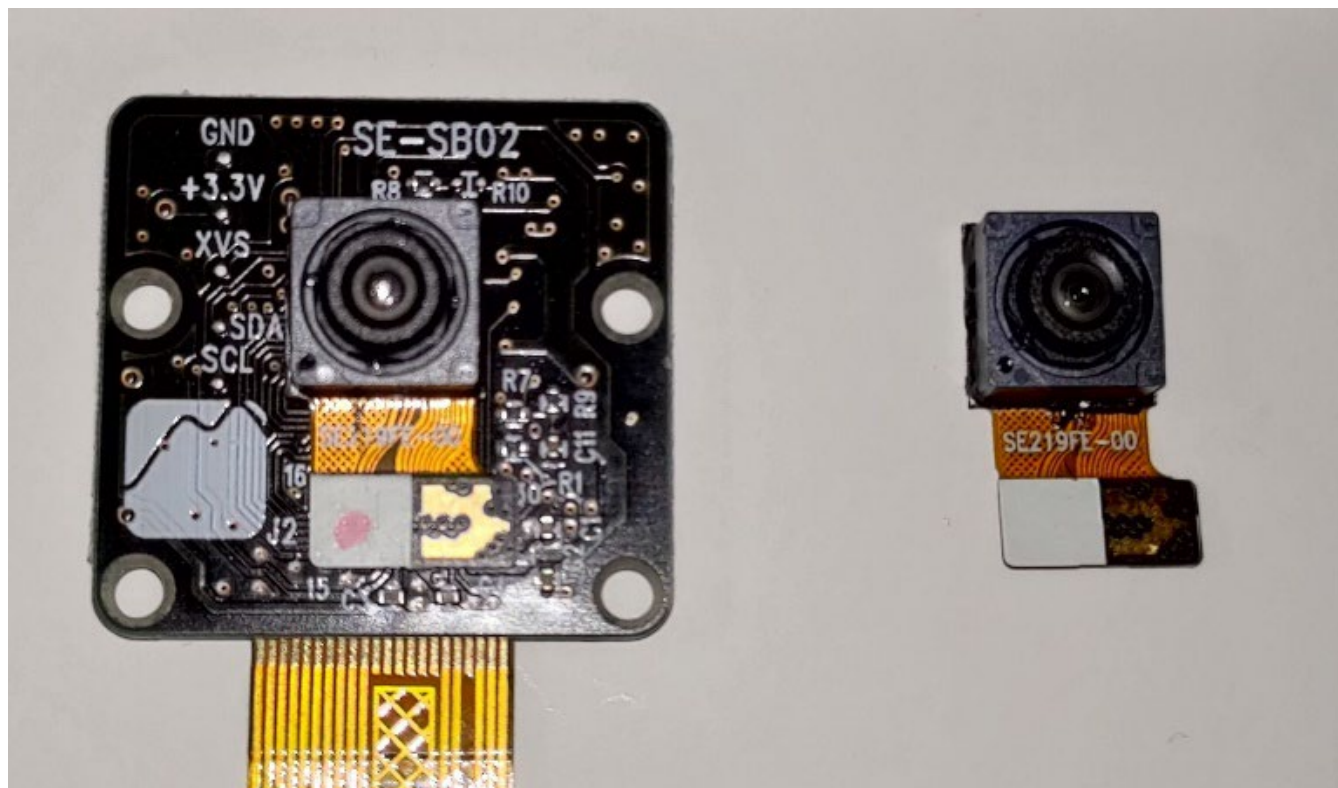

# Vision System向けイメージセンサーモジュール SE219AF-00-CB (w/ IRCF), SE219AF-01-CB (w/o IRCF)

想定適用例：AR/VRゴーグル用カメラ、スマートグラス、ウェアラブルカメラ

FoV=76°、待望のフォーカスドライバ内蔵のIMX219カメラモジュール  
3cm～無限遠(要調整)でフォーカス合わせが可能。  
シャープなイメージのマクロ撮影において特に性能を発揮  
Tinker BoardのカメラドライバーにAF機能実装検討中

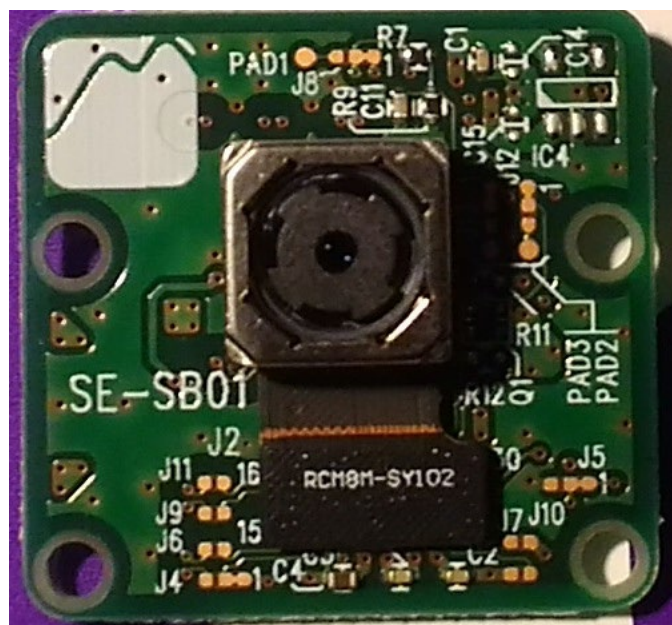



# FoV=160° 魚眼カメラ SE219FE160-00-CB (w/ IRCF), SE219FE160-01-CB (w/o IRCF)

想定適用例：広角3D動画、ドアホン、見守り監視、自律移動ロボットのセンシングなど。

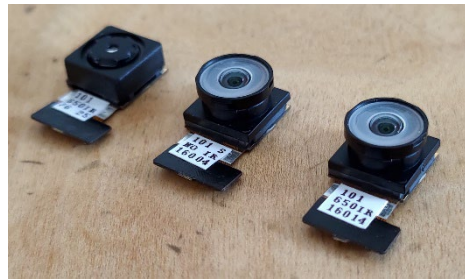

Soho Enterprise Ltd.

SE Camera Board Series Product Brochure

Fish-Eye lens nodule w/ 8Mpix CIS for Single Board Computers

## SE219FE160-00/01

- Ultra Wide View Angle: FoV = 160° ± TBD°  
Suitable for wide angle image recognition usage in AIoT area.
- Adopted the most mature image sensor for SBC.  
Sony IMX219PQH5-C
- w/ IRCF (-00), w/o IRCF (-01) modules are available
- Extensivity:  
FFC connector for MIPI CSI-2 4 lane connection for faster fps.

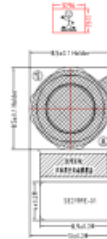

To Be Replaced

Pin Assignment

No.	Pin Name	No.	Pin Name
1	NC	26	DGND
2	NC	27	MPI-D0N
3	DVDD1.2V	28	MPI-DSP
4	DVDD1.2V	29	DGND
5	Sensor-PWDN	30	MPI-D0N
6	DGND	31	MPI-DSP
7	MCLK	32	DGND
8	DGND	33	MPI-D0N
9	AGND	34	MPI-DSP
10	MCLK	35	DGND
11	SPDVSVEI	36	MPI-CLKP
12	DGND	37	MPI-CLKP
13	MPI-DSP	38	DGND
14	MPI-D0N	39	SCL1.8V
15	DGND	30	SCL1.8V

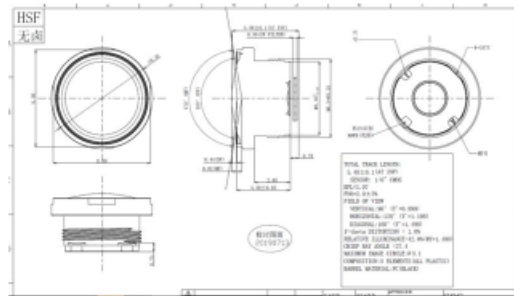

IMX219  
D=4.6mm

Imaging area & Image circle

### Assumed application cases

- Look down monitoring with few blind spots
- Monitoring wildlife ecology, harm to agriculture
- OVR Stereo Vision
- Home-use video monitoring & recording
- Wide vision for Robots, AI speaker, any others

SE Camera Board Series Product Brochure

Key Specifications		SE219FE-00/01-CB	
Image Sensor	Manufacturer	Sony	Back-side illuminated CMOS image sensor
	Pixel size	1.12um x 1.12um	
	Active Image Area	3280 x 2464	8Mpix
	Optical Size	Type 1/4 Diagonal	4.60mm
Lens	Operation Temperature	-20~80°C	Function guarantee
	Storage Temperature	-30~80°C	Performance guarantee
	Configuration	Type 1/6, 5P	
	FoV	160°	±(TBD)°
Module	F No.	2.0 ± 5%	
	Focus range	30cm ~ Infinity	Adjusted at 60cm when shipped (TBD)
	Connector	30pin	Compatible w/ Raspi Camera v2.1 module
	Size	8.5mm*8.5mm*TBDmm	Lens Holder size: Same (x, y) size to Raspi module
Weight	Weight	0.4g(Tentative)	
	Analog	2.8V ± 0.2V	
Power Supply	Digital	1.2V ± 0.12V	
	IO	1.8V ± 0.18V	
Size	Size	25mm*24mm	Almost same size and compatible position for screw holes with RaspberryPi camera v2.1.
	Connector	1.0mm pitch 15pin	For Tinker board, RaspberryPi
Board (option)	Connector	0.5mm pitch 22pin	RaspberryPi0, Raspi compute module, etc.
	I/O Format		Support MIPI CSI-2 2lane and 4 lane
	Output	Maximum speed	Full size: 30fps, FHD: 60fps, 720P: 180fps (MIPI 4 lane mode)
	Power Supply	3.3V ± 0.3V	Generate Analog 2.8V by on-board LDO Generate Digital 1.2V by on-board DD-converter. Generate Analog 1.8V by on-board LDO Generate AF 2.8V by on-board optional LDO

### Why are the SE camera boards suitable for AIoT vision processing applications?

- Good image quality**  
The SE camera series uses a high-quality Sony image sensors of better SNR.
- Ready to use on tinker board and other SBCs**  
Camera drivers are ready. Easy to customize for PoC prototyping
- Variety of Options**  
Wide variety of options for resolution, global shutter, wide FoV lens, focus driver, etc.
- Low Latency, RAW image**  
Suitable for real-time autonomous control system
- Affordable for everyone**  
Pricing that individuals can purchase from a single item in line with the corporate philosophy of *helping to create open innovation.*

### Further Information:

<https://soho-enterprise.com/>  
<https://www.visionproc.org/index.php>



## New Release

### Vision System向けイメージセンサーモジュール

SE132GSFF-00/01-CB02

SE132GSFE160-00/01-CB02

中国SMARTSENS TECHNOLOGY社の最新Global Shutter Image Sensorをモジュール化しました。

最高品質の台湾TSMC社で製造される裏面照射型イメージセンサーです。

画素サイズ2.7um, 1,080x1,280=1.3Mpixel

SE219シリーズと同じ光学サイズ1/4”型で豊富なレンズバリエーションが用意できます。

- ・ 120fpsの高速撮像
- ・ 赤外領域の感度が向上
- ・ RaspberryPiとの接続を確認済み
- ・ FoV=120°、150度° 187° 等計画中

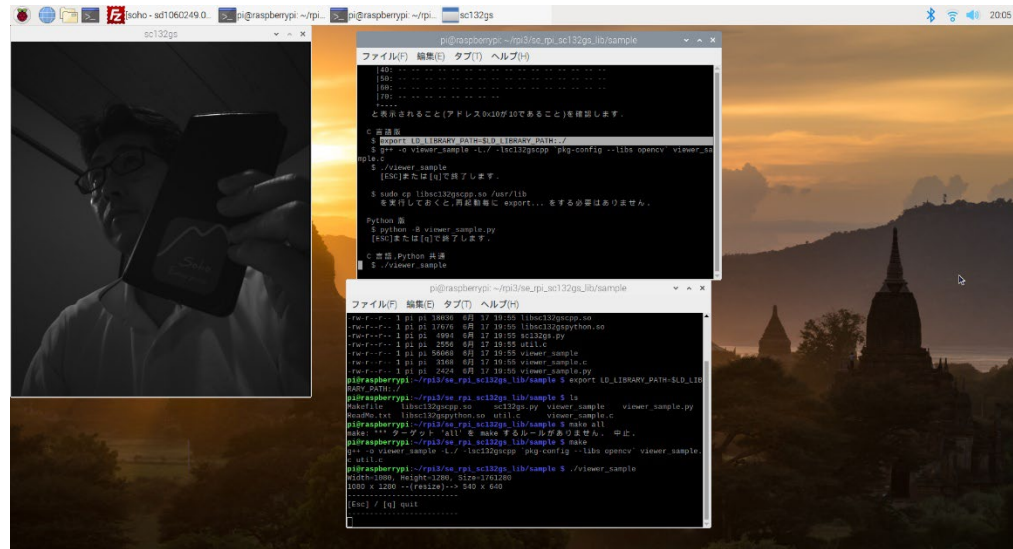





Soho Enterprise Ltd.

SE Camera Board Series Product Brochure

Fish-Eye lens module w/ 1.3Mpix Global Shutter CIS for SBCs

## SE132GSFF/FFW/FE160/PKG-01

### Many of lens option

Adopted the best-in-class global shutter CMOS image sensor of BSI, Smartsens SC132GS

Customized Optical Filters (IRCF, BPF) will be available

### Extensivity:

MIPI CSI-2 4 lane connection for faster fps.

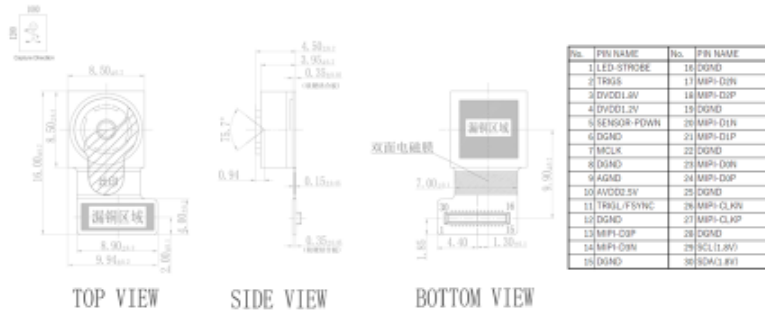

Imaging area & image circle

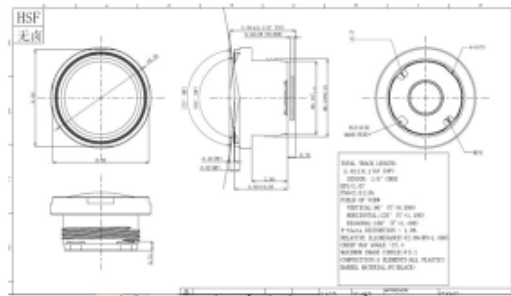
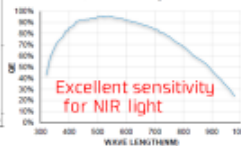

Wide Angle (Fish-Eye) Lens

### Assumed application cases

- Wide vision for Robots of autonomous driving
- 3D sensing with NIR structured light

Ver. 0.9.3

SE Camera Board Series Product Brochure

### Key Specifications SE132GSFE160-00/01

Image Sensor	Product Code: SC132GS	Manufacturer	Smartsens Back-side illuminated, Global Shutter
		Pixel size	2.7um x 2.7um
		Active Image Area	1080 x 1280 1.3Mpix
		Optical Size	Type 1/4 Diagonal 4.53mm
		Operation Temperature	-40~85°C Function guarantee -20~60°C Performance guarantee
Module	Lens	Maximum Frame Rate	120fps
		Configuration	Type 1/6, 5P
		FoV	160° ±(TBD)°
		F No.	2.0±5%
		Focus range	30cm ~ Infinity, Adjusted at 60cm when shipped.(TBD)
Board (option)	Connector	30pin	Compatible w/ Raspi Camera v2.1 module
	Size	10.5*10.5*6.3mm(TBD)	Lens Holder size: 8.5 * 8.5 * 6.3mm by COB
	Weight	0.4g(Tentative)	
	Power Supply	Analog	2.5V±0.1V
		Digital	1.2V±0.06V
IO		1.8V±0.1V	
Board (option)	Size	25mm* 24mm	Almost same size and compatible position for screw holes with RaspberryPi camera V2.1.
	Connector	1.0mm pitch 15pin	For Tinker board, RaspberryPi
		0.5mm pitch 22pin	RaspberryPi0, Raspi compute module, etc.
	Output	I/O Format	Support MIPI CSI-2 2lane and 4 lane
		Maximum speed	Full size: 120fps (MIPI 4 lane mode)
Power Supply	3.3V±0.3V		Generate Analog 2.8V by on-board LDO
			Generate Digital 1.2V by on-board DD-converter.
			Generate Analog 1.8V by on-board LDO
			Generate AF 2.8V by on-board optional LDO

### Why are the SE camera boards suitable for AIoT vision processing applications?

- Good image quality**  
The SE camera series uses a high-quality image sensors of better SNR.
- Ready to use on tinker board and other SBCs**  
Camera drivers are ready. Easy to customize for PoC prototyping
- Variety of Options**  
Wide variety of options for resolution, global shutter, wide FoV lens, focus driver, etc.
- Low Latency, RAW image**  
Suitable for real-time autonomous control system
- Affordable for everyone**  
Pricing that individuals can purchase from a single item in line with the corporate philosophy of *helping to create open innovation.*

### Further Information:

<https://soho-enterprise.com/>  
<https://www.visionproc.org/index.php>



Ver. 0.9.3

# OPNOUS Full Product



### GENERAL DESCRIPTION

OPN8001/8008/8018 are Time-of-Flight (ToF) imaging sensors for 3D sensing covering 100x100 / QVGA (256x240) / VGA (640x480) level multi-sensing resolution. The 3D sensing is realized upon 850 nm and 940 nm NIR wave length with an industry leading accuracy. The power consumption achieves the lowest power level in the industry, which benefits many portable and energy saving applications. OPN8001/8008/8018 are developed as key products of OPNOUS ToF solutions for a broad range of applications.



### GENERAL DESCRIPTION

The OPN7007 is a smart VCSEL laser diode driver with high performance and high efficiency, which is optimized for Time of Flight (ToF) camera application. It is embedded with configurable current limit function to output specific peak current for illumination. A 12-bit ADC is also integrated for eye protection and temperature monitoring. The OPN7007 supports PC interface configuration.



### FUNCTIONAL DESCRIPTION

OPN6001 is a high performance, low power, low cost application processor (dedicated for ToF sensor). It is embedded with a sophisticated ToF ISP covering the ToF raw data to easy use distance in 4K day. With its novel self-cleaning engine, it also automatically turns lights and sensors to get best image with different scenarios. A 30MHz ARM Cortex-M3 processor is also integrated to handle system controlling and on-line operations. It can support up to 3 ToF sensors simultaneously with 800/940 nm lasers, range different sources and transmit the data to host AP by USB, UART, I2C or SPI/SDIO interface.



### FUNCTIONAL DESCRIPTION

The OPNE8008B is our Evaluation Kit for the QVGA OPN8008B Time-of-Flight (ToF) Sensor. This Evaluation Kit is fully assembled and tested camera system designed for the evaluation of the OPN8008B QVGA ToF Sensor, which provides all necessary hardware to operate OPN8008B, including both the camera lens and illumination. It can be directly connected to a PC for real-time visualization and recording of depth map data, while allowing direct access to many configuration settings. The system is fully controllable by an intuitive GUI on a PC.



### GENERAL DESCRIPTION

Opnus provides a series of Time-of-Flight (ToF) imaging modules fitting for a broad range of 3D sensing applications. These 3D sensing modules are realized upon 850 nm and 940 nm NIR wave length with an industry leading accuracy. The power consumption achieves the lowest power level in the industry, which benefits many portable and energy saving applications.

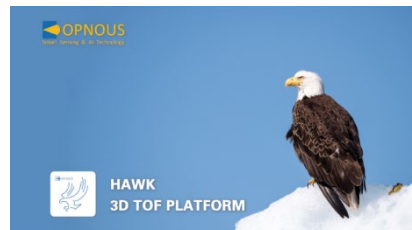

### GENERAL DESCRIPTION

Hawk 3D ToF platform consists of OPNOUS ToF sensor OPN8008, VCSEL driver OPN7007 and ToF ISP OPN6001. It has built-in high performance, low power consumption ToF signal processing features -- auto-exposure(AE), high dynamic range(HDR), spatial and temporal de-noise and multi-device interference immunity. Hawk 3D ToF platform provides an easy-to-integrate ToF 3D vision solution for mid and long range applications.

Hawk 3D ToF platform can connect to host computer via USB 3.0 UVC protocol. Its SDK supports Windows and Ubuntu on x86 architecture.

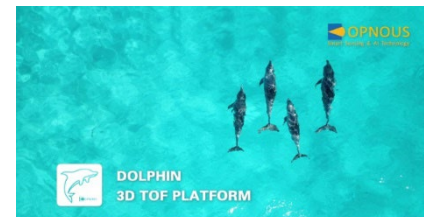

### GENERAL DESCRIPTION

Dolphin 3D ToF platform consists of OPNOUS ToF camera module and ToF ISP chip OPN6001. Dolphin has built-in high performance, low power consumption ToF signal processing features -- auto-exposure(AE), high dynamic range(HDR), spatial and temporal de-noise and multi-device interference immunity.

Dolphin 3D ToF platform can connect to embedded application processor via MIPI interface or to computer via USB 3.0 UVC protocol. Dolphin SDK supports Windows and Ubuntu on x86 architecture and embedded Linux on embedded ARM processors.

Dolphin 3D ToF platform provides an easy-to-integrate ToF 3D vision solution for 3D applications within 5-meter range, such as facial recognition, machine vision, SLAM, 3D re-construction, AR/VR, etc.

